

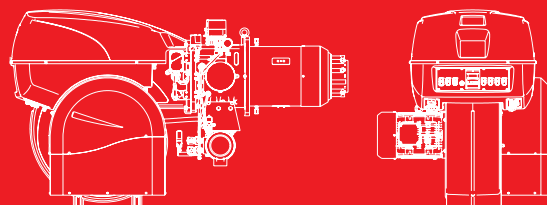

# RLS 500÷1200/M Series

Low NOx Progressive Two-Stage or Modulating Operation Burners

RLS 500/M MX	1120/2500	÷	5050	kW
RLS 650/M MX	1430/3000	÷	6550	kW
RLS 800/M MX	1750/3500	÷	8000	kW
RLS 1000/M MX	1200/3750	÷	10600	kW
RLS 1200/M MX	1500/5500	÷	11500	kW



RLS/M burners are characterised by a modular monoblock structure that means all necessary components can be combined in a single unit thus making installation easier, faster and, above all, more flexible.

The series covers a firing range from 2500 to 11500 kW, and it has been designed for use in hot water boilers, overheated water boilers as well as steam boilers.

Operation can be "two stage progressive" or alternatively "modulating", for both fuels, light oil and gas, with the installation of a PID logic regulator .

The mechanical cam device of regulation allows to catch up a high modulation ratio on all firing rates range. The burners can, therefore, supply with precision the demanded power, guaranteeing a high efficiency system level and the stability setting, obtaining fuel consumption and operating costs reduction.

The combustion head guarantees reduced polluting emissions (NOx < 80 mg/kWh on gas operation). An exclusive design guarantees low sound emissions, low electrical consumption, easy use and maintenance.

## Technical Data

MODEL			RLS 500/M	RLS 650/M	RLS 800/M
Burner operation mode			Progressive two-stage or modulating		
Modulation ratio at max. output			4 ÷ 1		
Servomotor	type	SQM 10.1			
	run time s	42s / 130°			
Heat output	kW	1120/2500 ÷ 5050	1430/3000 ÷ 6550	1750/3500 ÷ 8000	
	Mcal/h	963/2150 ÷ 4342	1230/2580 ÷ 5632	1505/3009 ÷ 6879	
Working temperature			°C min./ max. 0/50		
<b>FUEL/AIR DATA</b>					
Light oil	net calorific value	kWh/kg	11.86		
	viscosity at 20°C	mm <sup>2</sup> /s (cSt)	4 ÷ 6		
	output	kg/h	95/211 - 425	121/253 - 552	148/295 - 675
Pump	type	TA5			
	output	kg/h	560 (at 16.5 bar)		
Atomised pressure		bar	6 - 30		
Fuel temperature		max. °C	140		
Fuel pre-heater			NO		
G20 gas	net calorific value	kWh/Nm <sup>3</sup>	10		
	gas density	kg/Nm <sup>3</sup>	0.71		
	gas delivery	Nm <sup>3</sup> /h	112/250 ÷ 505	143/300 ÷ 655	175/350 ÷ 800
G25 gas	net calorific value	kWh/Nm <sup>3</sup>	8.6		
	gas density	kg/Nm <sup>3</sup>	0.78		
	gas delivery	Nm <sup>3</sup> /h	--	--	--
LPG gas	net calorific value	kWh/Nm <sup>3</sup>	--	25.8	
	gas density	kg/Nm <sup>3</sup>	--	2.02	
	gas delivery	Nm <sup>3</sup> /h	--	--	
Fan		type	Forward curve blades		
Air temperature		max °C	60		
<b>ELECTRICAL DATA</b>					
Electrical supply		Ph/Hz/V	3/400/50 (±10%)	3N/400/50 (±10%)	
Auxiliary electrical supply		Ph/Hz/V	1/230/50 ~ (±10%)	1/230/50 ~ (±10%)	
Control box		type	LFL 1.333		
Total electrical power		kW	15.8 (oil) / 14 (gas)	22.5 (oil) / 20.8 (gas)	24.8 (oil) / 23 (gas)
Auxiliary electrical power		kW	-	-	-
Heaters electrical power		kW	-	-	-
Protection level		IP	54		
Fan motor	electrical power	kW	12	18.5	21
	rated current	A	21.2 - 12.2	35.7 - 20.6	41.8 - 24.2
	start up current	A	7 x I <sub>n</sub>		
	protection level	IP	54		
Pump motor	electrical power	kW	1.5		
	rated current	A	5.9/3.4		
	start up current	A	7 x I <sub>n</sub>		
	protection level	IP	54		
Ignition transformer	V1 - V2	230V - 2 x 5 kV		230V - 1 x 8 kV	
	I1 - I2	1.9 A - 35 mA		1 A - 20 mA	

MODEL			RLS 500/M	RLS 650/M	RLS 800/M
Operation			Intermittent (at least one stop every 24 h)		
<b>EMISSIONS</b>					
Noise levels	sound pressure	dB (A)	86.5	80.1	89.6
	sound power	W	100.5	104.3	103.9
Light oil	CO emission	mg/kWh	< 10	< 10	< 10
	grade of smoke indicator	N° Bacharach	< 2	< 2	< 2
	CxHy emission	mg/kWh	< 2	< 2	< 2
	NOx emission	mg/kWh	< 185	< 185	< 185
Gas G20	CO emission	mg/kWh	< 10	< 10	< 10
	NOx emission	mg/kWh	< 80	< 80	< 80
<b>APPROVAL</b>					
Directive			2006/42 - 2009/142 - 2004/108 - 2006/95 EC		
Conforming to			EN 267 - EN 676		
Certification			CE-0085CLO207	CE-0085CLO207	CE-0085CLO422

MODEL		RLS 1000/M	RLS 1200/M
Burner operation mode		Progressive two-stage or modulating	
Modulation ratio at max. output		7 ÷ 1 (oil and gas)	
Servomotor	type	SQM10.1	
	run time s	42s / 130°	
Heat output	kW	1200/3750 ÷ 10600	1500/5500 ÷ 11500
	Mcal/h	987/3109 ÷ 8557	1688/4560 ÷ 9297
Working temperature		°C min./ max. 0/50	

<b>FUEL/AIR DATA</b>					
Light oil	net calorific value	kWh/kg	11,86		
	viscosity at 20°C	mm <sup>2</sup> /s (cSt)	4 ÷ 6		
Pump	output	kg/h	100/315 - 867	171/462 - 942	
	type		VBHRG	VBHGRP	
Atomised pressure	output	kg/h	1400 (at 30 bar)	1826 (at 30 bar)	
	bar		9 ÷ 40	9 ÷ 40	
Fuel temperature		max. °C	140	140	
Fuel pre-heater			NO		
G20 gas	net calorific value	kWh/Nm <sup>3</sup>	10		
	gas density	kg/Nm <sup>3</sup>	0,71		
	gas delivery	Nm <sup>3</sup> /h	50/135 ÷ 380	80/180 ÷ 450	
G25 gas	net calorific value	kWh/Nm <sup>3</sup>	8,6		
	gas density	kg/Nm <sup>3</sup>	0,78		
	gas delivery	Nm <sup>3</sup> /h	58/156 ÷ 442	93/209 ÷ 523	
LPG gas	net calorific value	kWh/Nm <sup>3</sup>	25,8		
	gas density	kg/Nm <sup>3</sup>	2,02		
	gas delivery	Nm <sup>3</sup> /h	--		
Fan	type	Reverse curve blades			
Air temperature		max °C	60		

<b>ELECTRICAL DATA</b>					
Electrical supply		Ph/Hz/V	3N/400/50 (±10%)		
Auxiliary electrical supply		Ph/Hz/V	1/230/50-60 ~ (±10%)		
Control box		type	LFL1.333..		

MODEL			RLS 1000/M	RLS 1200/M
Total electrical power	kW		27 (oil) / 24 (gas)	31 (oil) / 27 (gas)
Auxiliary electrical power	kW			-
Heaters electrical power	kW			-
Protection level	IP			54
Fan motor	electrical power	kW	22	25
	rated current	A	38.6 - 22.3	44.1 - 25.5
	start up current	A		7 x In
	protection level	IP		54
Pump motor	electrical power	kW	2,2	4
	rated current	A	9.3 - 5.4	8.2
	start up current	A		7 x In
	protection level	IP		54
Ignition transformer	V1 - V2		230V - 1 x 8 kV	
	I1 - I2		1 A - 20 mA	
Operation			Intermittent (at least one stop every 24 h)	
<b>EMISSIONS</b>				
Noise levels	sound pressure	dB (A)	85,4	84,4
	sound power	W	100,6	99.7
Light oil	CO emission	mg/kWh		< 10
	grade of smoke indicator	N° Bacharach		< 2
	CxHy emission	mg/kWh		< 2
	NOx emission	mg/kWh		< 250
Gas G20	CO emission	mg/kWh		< 10
	NOx emission	mg/kWh		< 80
<b>APPROVAL</b>				
Directive			2006/42 - 2009/142 - 2004/108 - 2006/95 EC	
Conforming to			EN 267 - EN 676	
Certification			CE-0085CN0120	

Reference conditions:

Temperature: 20°C - Pressure: 1013,5 mbar - Altitude: 0 m a.s.l. - Noise measured at a distance of 1 meter.

Since the Company is constantly engaged in the production improvement, the aesthetic and dimensional features, the technical data, the equipment and the accessories can be changed. This document contains confidential and proprietary information of RIELLO S.p.A. Unless authorised, this information shall not be divulged, nor duplicated in whole or in part.

# Firing Rates

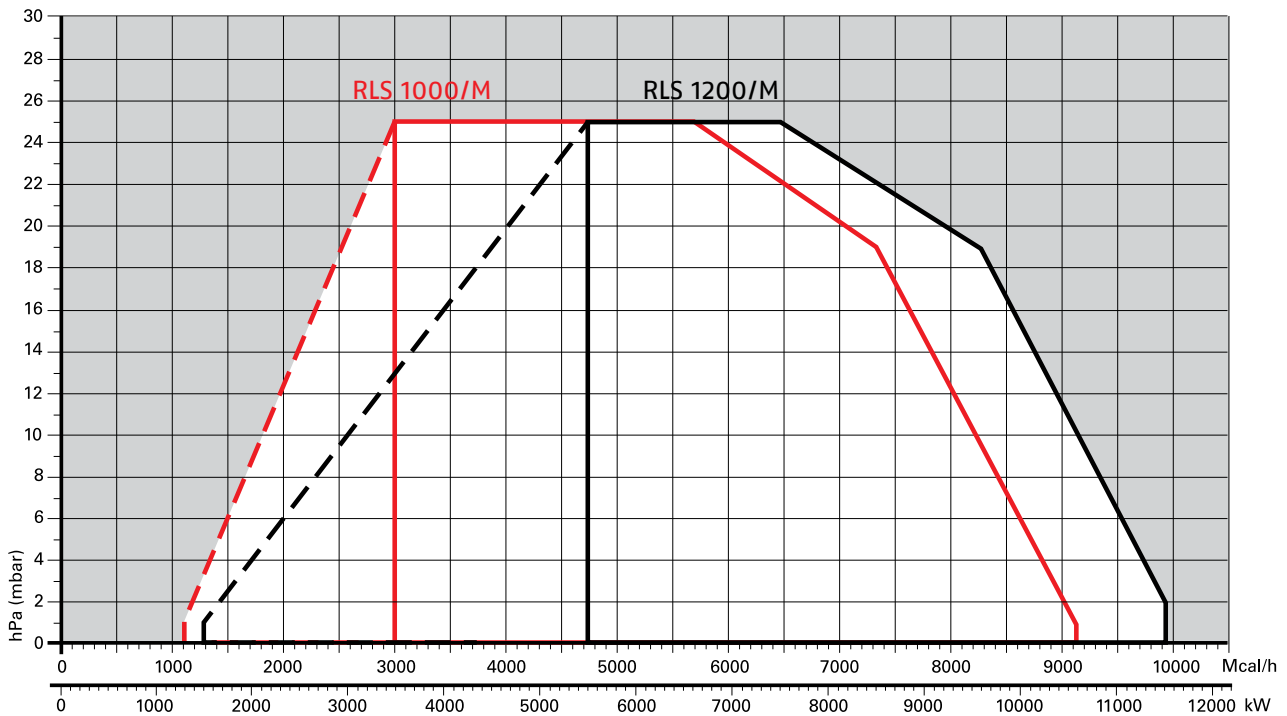
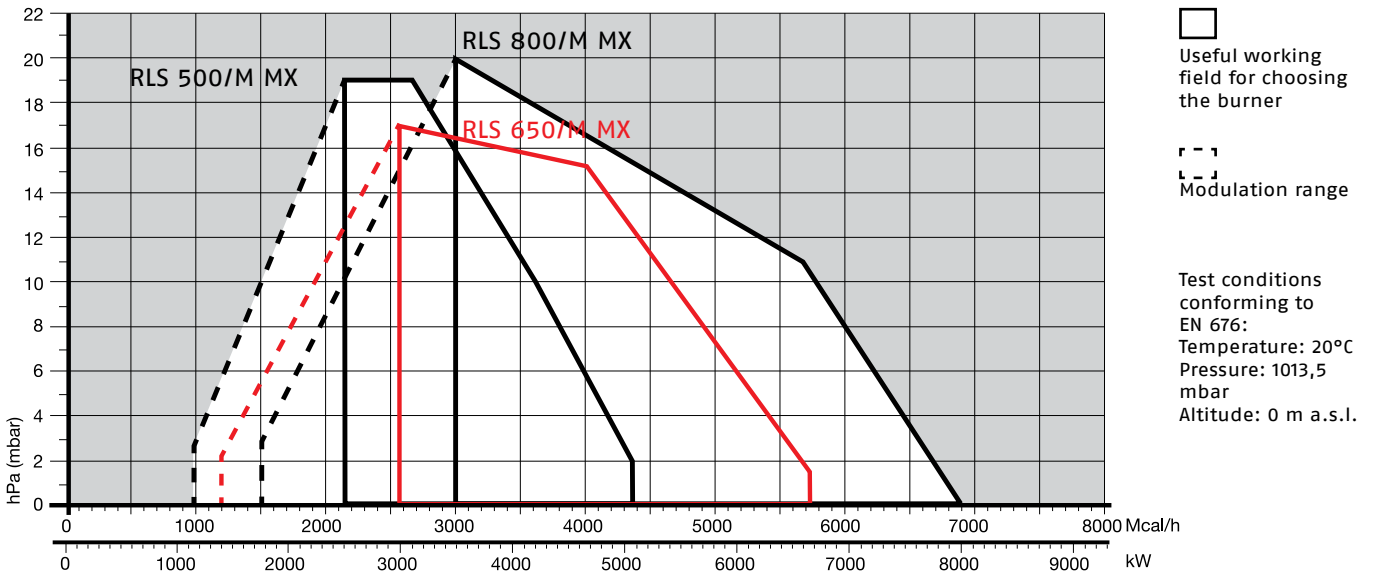

# Fuel Supply

## GAS TRAIN DESIGNATION

Series:

MB
MBC
DMV
DMV12
VGD
CB
CBH
MV
CG

Size:	405	407	410	412	415	420							
		65	120	300	700	1200	-	1900	3100	5000			
	505	507	510	512	-	520	525	5065	5080	50100	50125	50150	
	10	15	20	32	40	-	50	-	65	80	100	125	150
		120	220										

Operation:

/S	only ON-OFF function
/1	stage mode opening
/2	2nd stage mode opening
/P	1st stage mode opening with air/gas proportional regulator

Leak detection control:

-	0
CT	leak detection control device installed on the gas train
CQ	equipped with pressure switch for leak detection control

Joint type:

R	threaded joint
F	standard flange ISO
F1	square flange BS1
F2	square flange BS2
F3	square flange BS3 - BS4

Electrical connection:

T	Terminals - Terminal strip
SD	Domestic plug
SM	Medium voltage plug

Standard output pressure range:

-	without pressure governor
0	with governor and air/gas proportional pressure
2	with governor and output pressure up to 20 mbar
3	with governor and output pressure up to 30 mbar
4	with governor and output pressure up to 40 mbar
5	with governor and output pressure up to 50 mbar
6	with governor and output pressure up to 60 mbar
8	with governor and output pressure up to 80 mbar
15	with governor and output pressure up to 150 mbar

Valve control:

0	shared
2	separate

CB	5065	/1	CT	F	SM	3	0
----	------	----	----	---	----	---	---

BASIC DESIGNATION

EXTENDED DESIGNATION

**GAS TRAINS**

The burners are fitted with a butterfly valve to regulate the fuel, controlled by the main management module of burner through a high precision servomotor.

Fuel can be supplied either from the right or left sides, on the basis of the application requirements.

A maximum gas pressure switch stops the burner in case of excess pressure in the fuel line.

The gas train can be selected to best fit system requirements depending on the fuel output and pressure in the supply line.

The gas trains are "Multibloc" and "Composed" type (assembly of the single components) with or without seal control.



Example of gas adjustment butterfly valve for RLS 500-650-800/M.



Example of gas adjustment butterfly valve for RLS 1000-1200/M.

**MB "THREADED"**

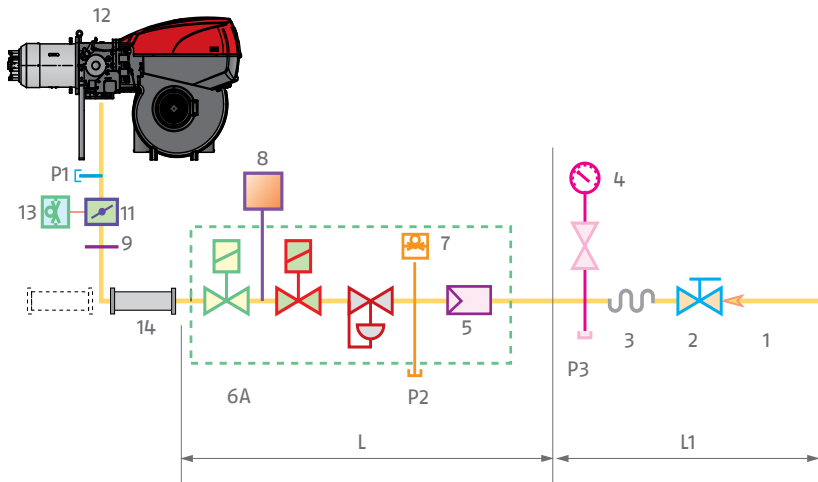

- 1** Gas input pipework
- 2** Manual valve
- 3** Anti-vibration joint
- 4** Pressure gauge with pushbutton cock
- 5** Filter
- 6A** Includes:
  - filter
  - operation valve
  - safety valve
  - pressure adjuster
- 7** Minimum gas pressure switch  
Leak detection device, supplied as an accessory or incorporated, based on the gas train code.
- 8**
- 9** Gasket, for "flanged" versions only
- 10** Pressure adjuster
- 11** Gas adjuster butterfly valve
- 12** Burner
- 13** Maximum gas pressure switch
- 14** Gas train-burner adaptor, supplied separately
- P1** Combustion head pressure
- P2** Upstream pressure of valves
- P3** Upstream pressure of the filter
- L** Gas train supplied separately, with the code given in the table
- L1** Installer' responsibility

**MBC "THREADED"**

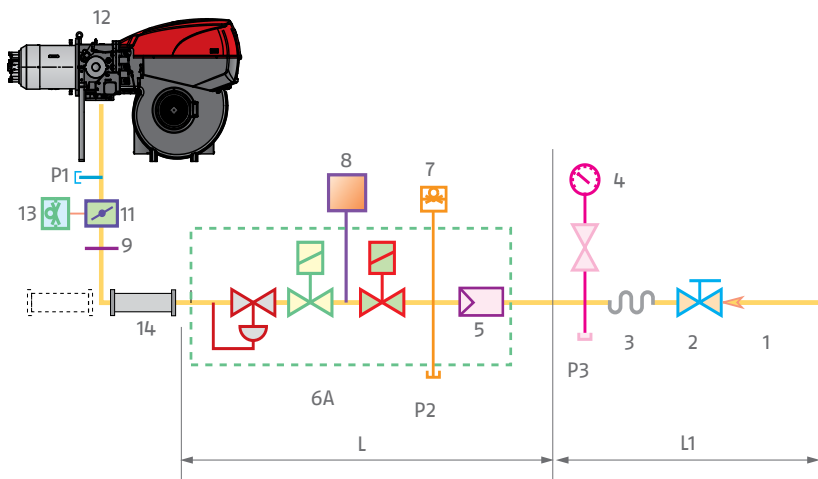



**MBC "FLANGED"**

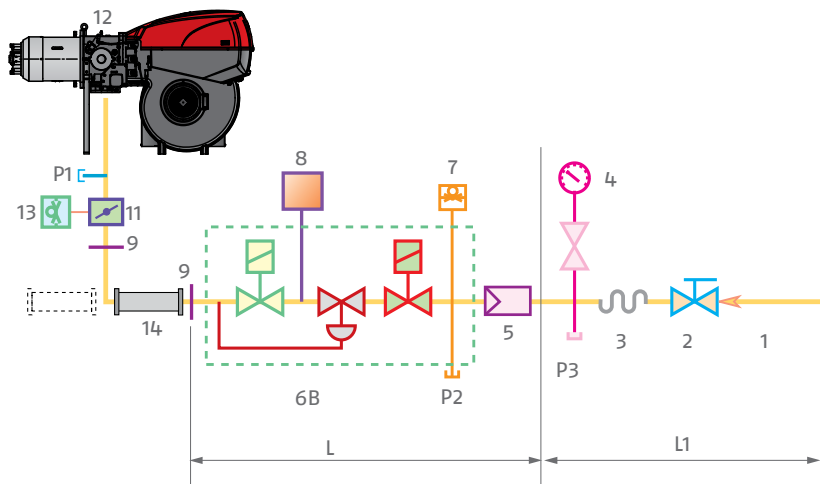

- 1** Gas input pipework
- 2** Manual valve
- 3** Anti-vibration joint
- 4** Pressure gauge with pushbutton cock
- 5** Filter
- 6B** Includes:
  - operation valve
  - safety valve
  - pressure adjuster
- 6C** Includes:
  - operation valve
  - safety valve
- 7** Minimum gas pressure switch  
Leak detection device, supplied as an accessory or incorporated, based on the gas train code.
- 8**
- 9** Gasket, for "flanged" versions only
- 10** Pressure adjuster
- 11** Gas adjuster butterfly valve
- 12** Burner
- 13** Maximum gas pressure switch
- 14** Gas train-burner adaptor, supplied separately
- P1** Combustion head pressure
- P2** Upstream pressure of valves
- P3** Upstream pressure of the filter
- L** Gas train supplied separately, with the code given in the table
- L1** Installer' responsibility

**CB "FLANGED OR THREADED"**

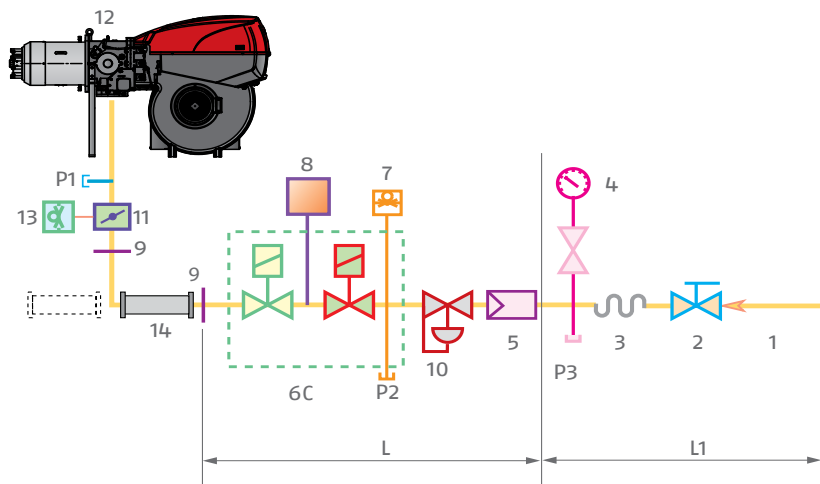

**DMV "FLANGED OR THREADED"**

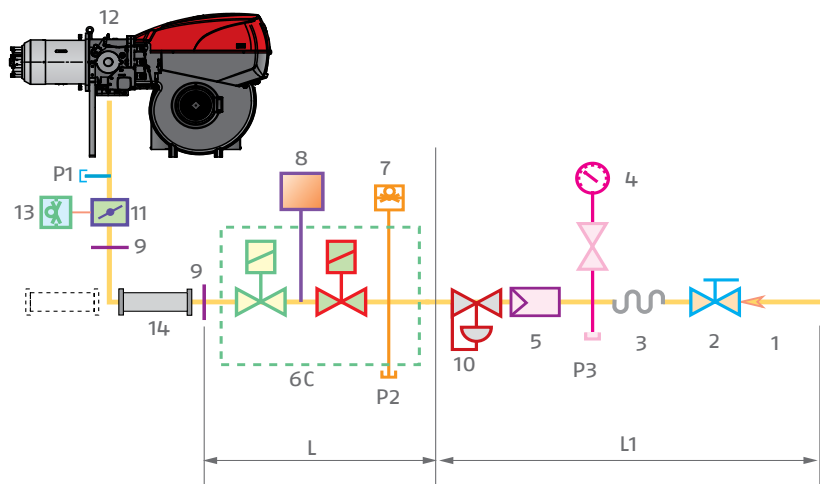

Gas trains are approved by standard EN 676 together with the burner.

The overall dimensions of the gas train depends on how they are constructed. The following table shows the maximum dimensions of the gas trains that can be fitted to RLS 500-650-800-1000-1200/M burners, intake and outlet diameters and seal control if fitted.

The maximum gas pressure of gas train "MULTIBLOC" type is 360 mbar, and that one of gas train "COMPOSED" type is 500 mbar.

"MULTIBLOC" guarantees a range of pressure towards the burner from 4 to 60 mbar. For version DN 65 and DN 80 is from 20 to 40 mbar. For version DN 100 is from 40 to 80 mbar. The range of pressure in the "MULTIBLOC" with flange can be modified choosing the stabiliser spring (see gas train accessory).

The maximum gas pressure of gas train "CB" series is 500 mbar. "CB" gas train guarantees a range of pressure towards the burner from 10 to 30 mbar. The range of pressure can be modified choosing the stabilizer spring (see accessories).

The maximum gas pressure of gas train "DMV" series is 500 mbar. "DMV" gas train is supplied without pressure governor.

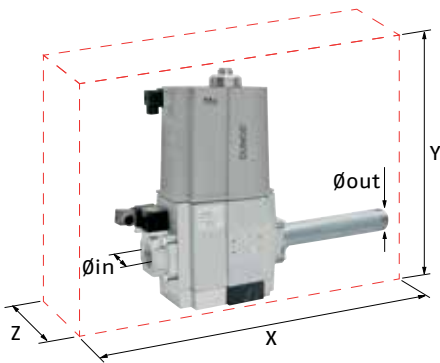

Example of gas train "MULTIBLOC" type without seal control (i.e. MBC 1200)

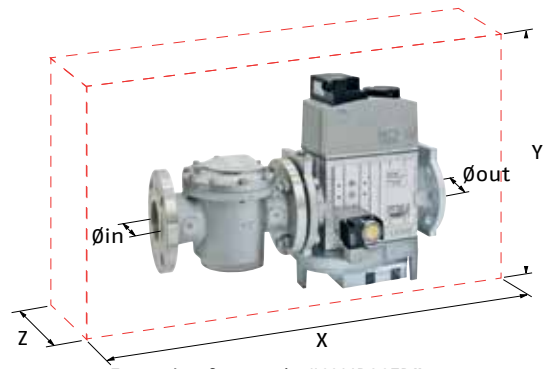

Example of gas train "COMPOSED" type without seal control (i.e. MBC 1900-3100-5000)



Example of gas train "CB" series with seal control

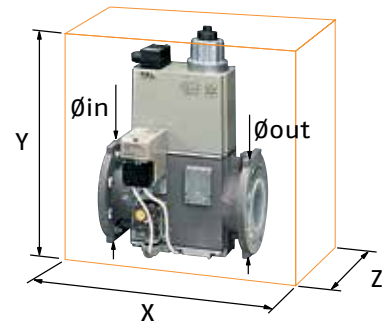

Example of gas train "DMV" series with seal control

GAS TRAIN						
MODEL	CODE	Ø in	Ø out	X mm	Y mm	Z mm
MB 415/1 - RT 30	3970180	Rp 1-1/2"	Rp 1-1/2"	523	250	100
MB 415/1 CT RT 30	3970198	Rp 1-1/2"	Rp 1-1/2"	523	250	229
MB 415/1 - RT 52	3970250	Rp 1-1/2"	Rp 1-1/2"	523	250	100
MB 415/1 CT RT 52	3970253	Rp 1-1/2"	Rp 1-1/2"	523	250	229
MB 415/1 RSM 30	3970232	Rp 1-1/2"	Rp 1-1/2"	523	250	100
MB 420/1 RT 30	3970181	Rp 2"	Rp 2"	523	289	100
MB 420/1 CT RT 30	3970182	Rp 2"	Rp 2"	523	289	229
MB 420/1 RT 52	3970257	Rp 2"	Rp 2"	523	289	100
MB 420/1 CT RT 52	3970252	Rp 2"	Rp 2"	523	289	229
MB 420/1 RSM 30	3970233	Rp 2"	Rp 2"	523	289	100
MB 420/1 CT RSM 30	3970234	Rp 2"	Rp 2"	523	289	229

<b>GAS TRAIN</b>						
<b>MODEL</b>	<b>CODE</b>	<b>∅ in</b>	<b>∅ out</b>	<b>X mm</b>	<b>Y mm</b>	<b>Z mm</b>
MBC 1200/1 - RSM 60	3970221	Rp 2"	Rp 2"	528	424	161
MBC 1200/1 CT RSM 60	3970225	Rp 2"	Rp 2"	528	424	290
MBC 1900/1 - FSM 40	3970222	DN 65	DN 65	613	430	237
MBC 1900/1 CT FSM 40	3970226	DN 65	DN 65	613	430	298
MBC 3100/1 - FSM 40	3970223	DN 80	DN 80	633	500	240
MBC 3100/1 CT FSM 40	3970227	DN 80	DN 80	633	500	319
MBC 5000/1 - FSM 80	3970224	DN 100	DN 100	733	576	280
MBC 5000/1 CT FSM 80	3970228	DN 100	DN 100	733	576	348

<b>GAS TRAIN</b>						
<b>MODEL</b>	<b>CODE</b>	<b>∅ in</b>	<b>∅ out</b>	<b>X mm</b>	<b>Y mm</b>	<b>Z mm</b>
CB 512/1 - RSM 30	3970145	Rp 1-1/2"	Rp 1-1/2"	891	261	245
CB 512/1 - CT RSM 30	20045589	Rp 1-1/2"	Rp 1-1/2"	891	261	245
CB 520/1 - RSM 30	3970146	Rp 2"	Rp 2"	986	328	255
CB 520/1 - CT RSM 30	3970160	Rp 2"	Rp 2"	986	328	255
CB 525/1 - RSM 30	20044659	Rp 2"	Rp 2"	1025	356	285
CB 525/1 - CT RSM 30	20044660	Rp 2"	Rp 2"	1025	356	285
CB 5065/1 - FSM 30	3970147	DN 65	DN 65	906	356	285
CB 5065/1 CT FSM 30	3970161	DN 65	DN 65	906	356	285
CB 5080/1 - FSM 30	3970148	DN 80	DN 80	934	416	285
CB 5080/1 CT FSM 30	3970162	DN 80	DN 80	934	416	285
CB 50100/1 - FSM 30	3970149	DN 100	DN 100	1054	501	350
CB 50100/1 CT FSM 30	3970163	DN 100	DN 100	1054	501	350
CB 50125/1 - FSM 30	20015871	DN 125	DN 125	1164	780	400
CB 50125/1 CT FSM 30	3970196	DN 125	DN 125	1164	780	400

<b>GAS TRAIN</b>						
<b>MODEL</b>	<b>CODE</b>	<b>∅ in</b>	<b>∅ out</b>	<b>X mm</b>	<b>Y mm</b>	<b>Z mm</b>
DMV 512/1 - RSM - 0	20043035	Rp 1-1/2"	Rp 1-1/2"	490	292	245
DMV 512/1 -CT RSM - 0	20043036	Rp 1-1/2"	Rp 1-1/2"	490	292	245
DMV 512/1 - CQ RSM - 2	20043037	Rp 1-1/2"	Rp 1-1/2"	490	292	245
DMV 520/1 - RSM - 0	20043038	Rp 2"	Rp 2"	490	292	255
DMV 520/1 CT RSM - 0	20043039	Rp 2"	Rp 2"	490	292	255
DMV 520/1 CQ RSM - 2	20043040	Rp 2"	Rp 2"	490	292	255
DMV 525/1 - RSM - 0	20043053	Rp 2"	Rp 2"	530	338	270
DMV 525/1 CT RSM - 0	20043054	Rp 2"	Rp 2"	530	338	270
DMV 525/1 CQ RSM - 2	20043055	Rp 2"	Rp 2"	530	338	270
DMV 5065/1 - FSM - 0	20043041	DN 65	DN 65	290	338	270
DMV 5065/1 CT FSM - 0	20043042	DN 65	DN 65	290	338	270
DMV 5065/1 CQ FSM - 2	20043043	DN 65	DN 65	290	338	270
DMV 5080/1 - FSM - 0	20043044	DN 80	DN 80	310	397	290
DMV 5080/1 CT FSM - 0	20043045	DN 80	DN 80	310	397	290
DMV 5080/1 CQ FSM - 2	20043046	DN 80	DN 80	310	397	290
DMV 50100/1 - FSM - 0	20043047	DN 100	DN 100	350	449	307
DMV 50100/1 CT FSM - 0	20043048	DN 100	DN 100	350	449	307
DMV 50100/1 CQ FSM - 2	20043049	DN 100	DN 100	350	449	307
DMV 50125/1 - FSM - 0	20043050	DN 125	DN 125	400	554	333
DMV 50125/1 CT FSM - 0	20043051	DN 125	DN 125	400	554	333
DMV 50125/1 CQ FSM - 2	20043052	DN 125	DN 125	400	554	333

# Pressure Drop Diagram

The diagrams indicate the minimum pressure drop of the burners with the various gas trains that can be matched with them; at the value of these pressure drop add the combustion chamber pressure. The value thus calculated represents the minimum required input pressure to the gas train.

The minimum input gas pressure required is 15 mbar while burner operating. In particular, the pressure difference between gas train upstream and downstream has to remain always over pressure drop values indicated below.

## RLS 500/M MX (NATURAL GAS)

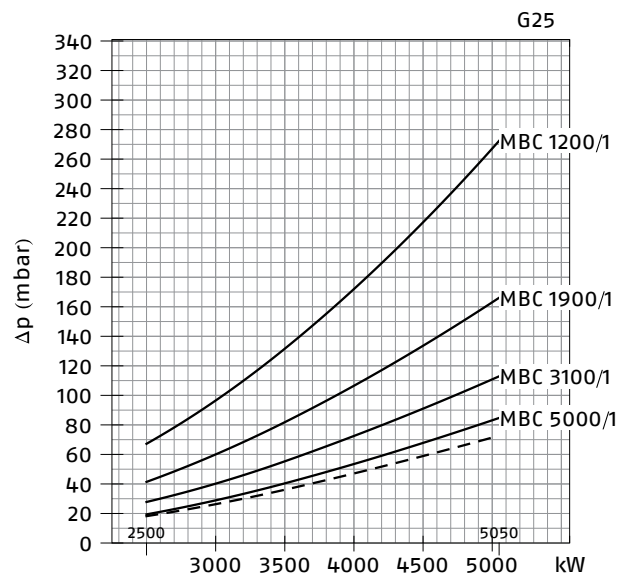
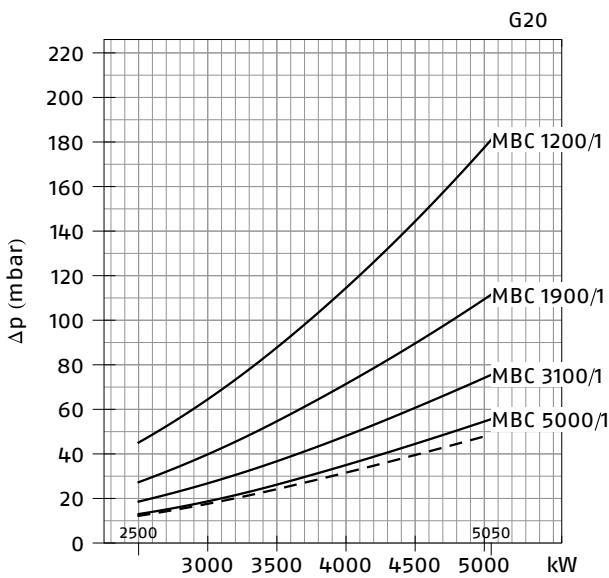

## RLS 500/M MX (NATURAL GAS)

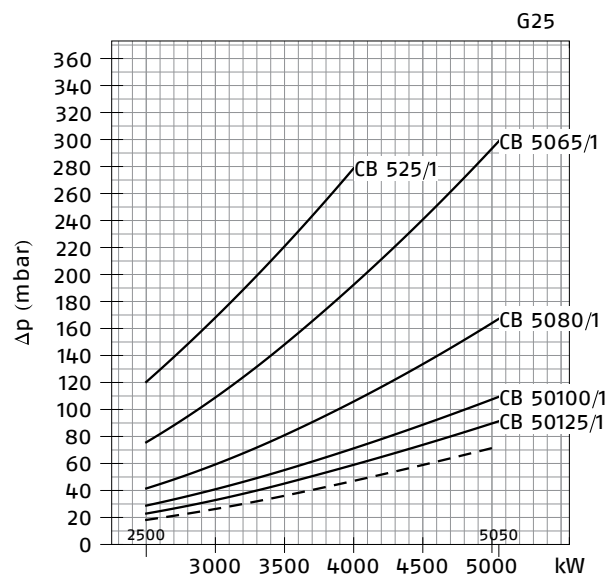
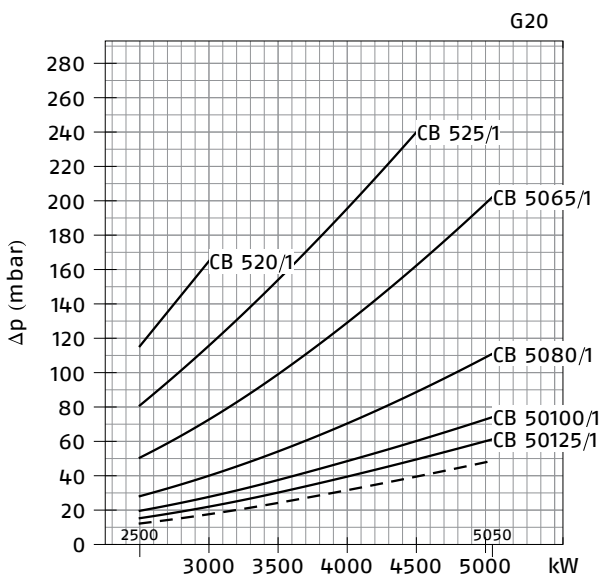

- Combustion head + gas butterfly valve + gas train
- - - Combustion head + gas butterfly valve

**RLS 500/M MX (NATURAL GAS)**

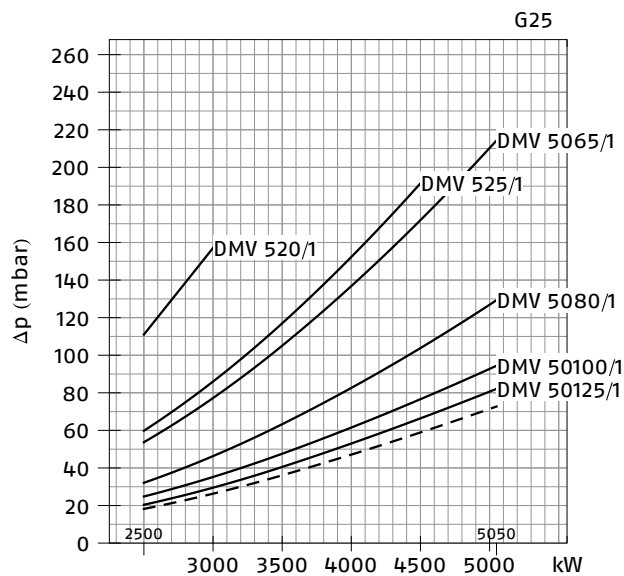
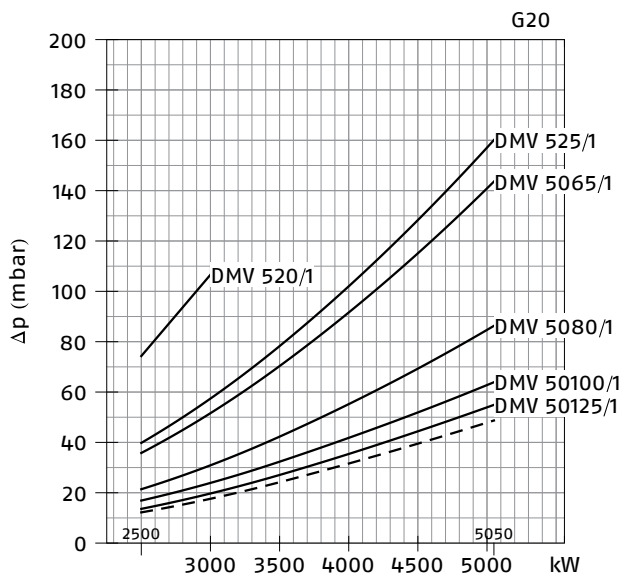

**RLS 650/M MX (NATURAL GAS)**

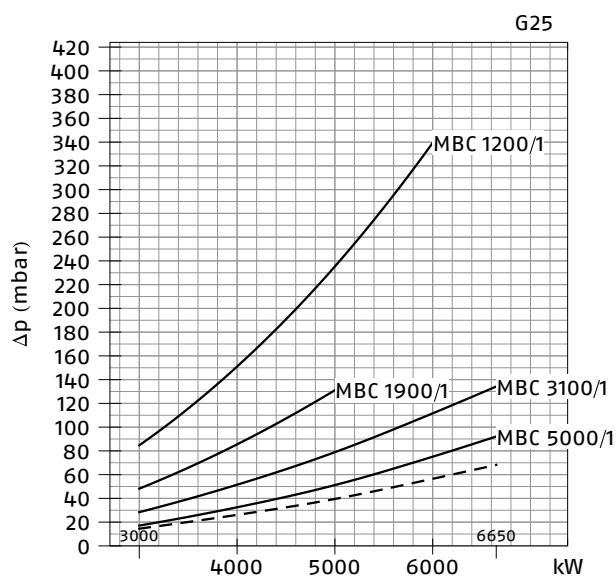
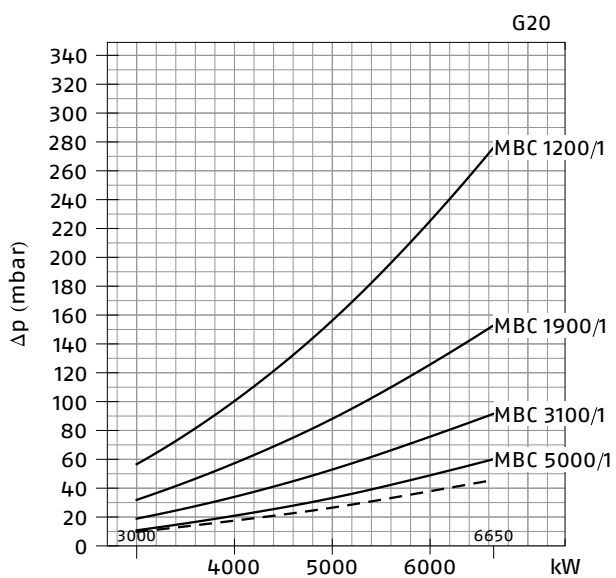

— Combustion head + gas butterfly valve + gas train  
 - - - Combustion head + gas butterfly valve

RLS 650/M MX (NATURAL GAS)

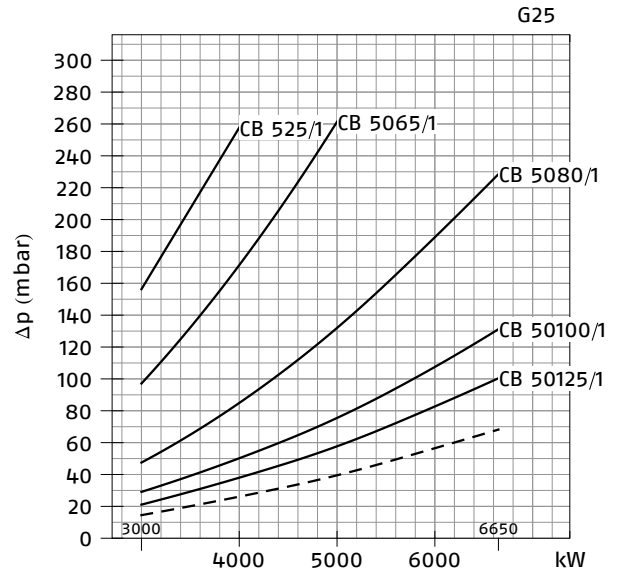
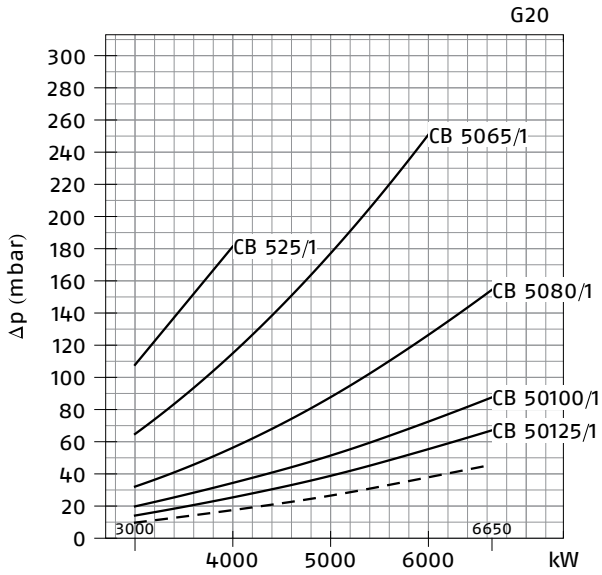

RLS 650/M MX (NATURAL GAS)

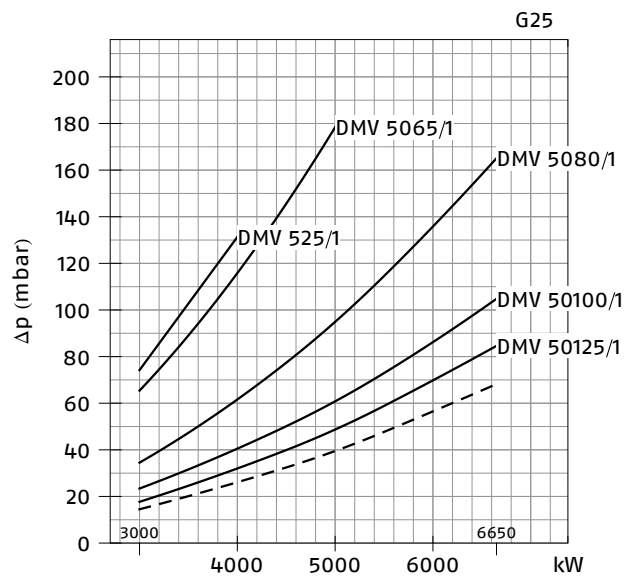
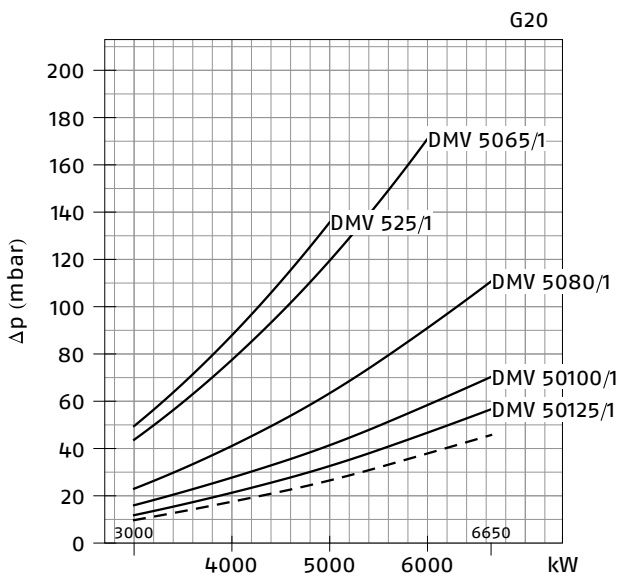

— Combustion head + gas butterfly valve + gas train  
 - - - Combustion head + gas butterfly valve

**RLS 800/M MX (NATURAL GAS)**

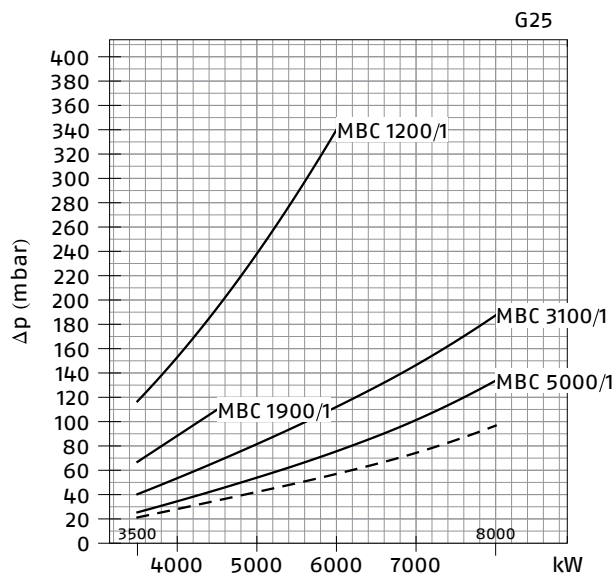
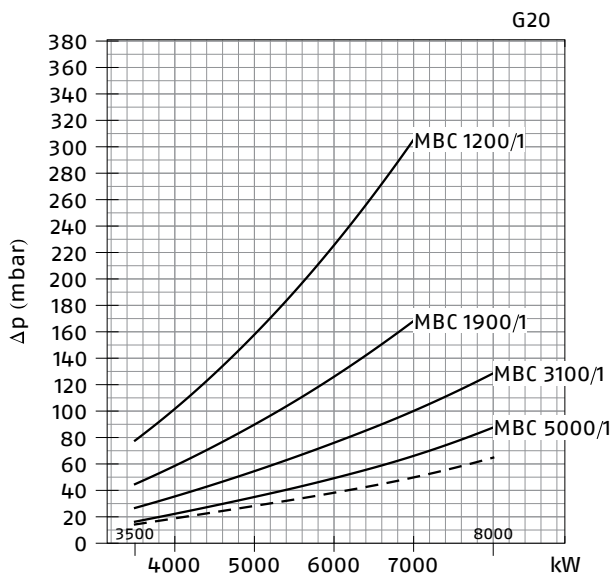

**RLS 800/M MX (NATURAL GAS)**

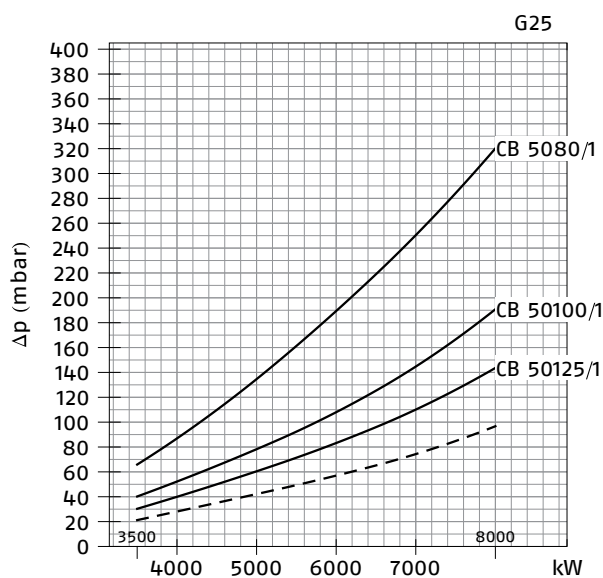
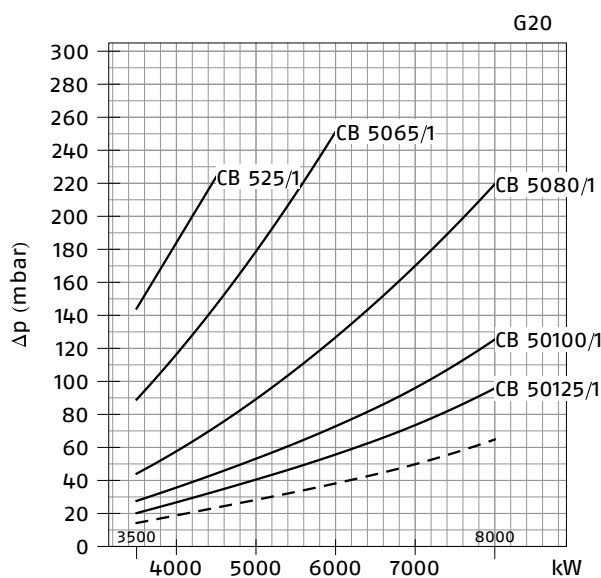

— Combustion head + gas butterfly valve + gas train  
 - - - Combustion head + gas butterfly valve

RLS 800/M MX (NATURAL GAS)

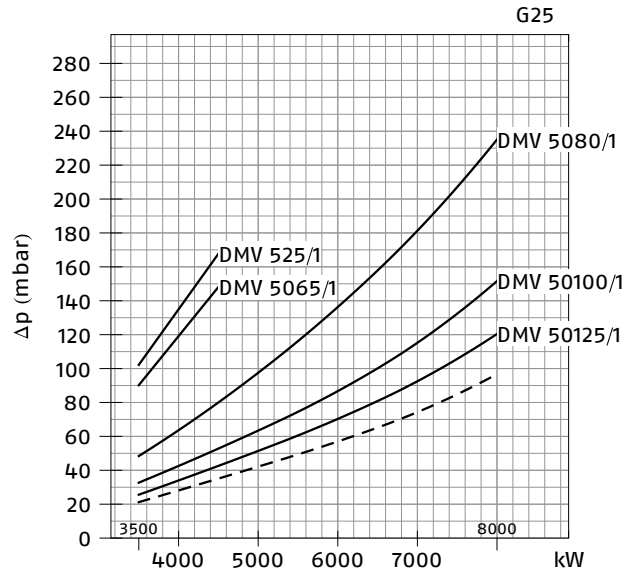
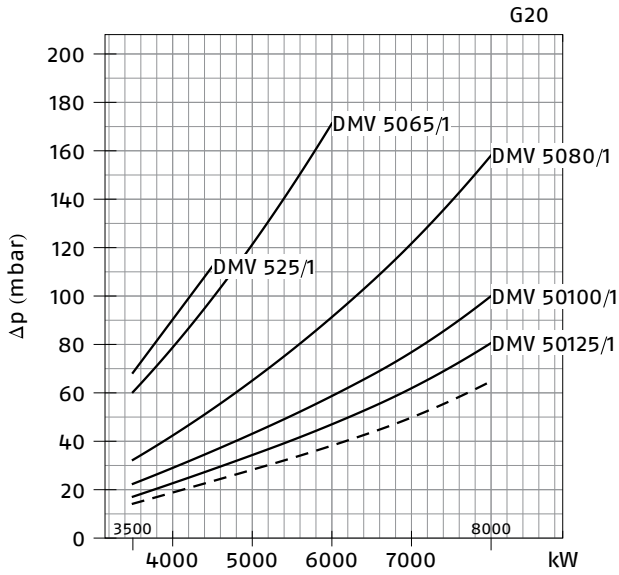

RLS 1000/M C13 (NATURAL GAS)

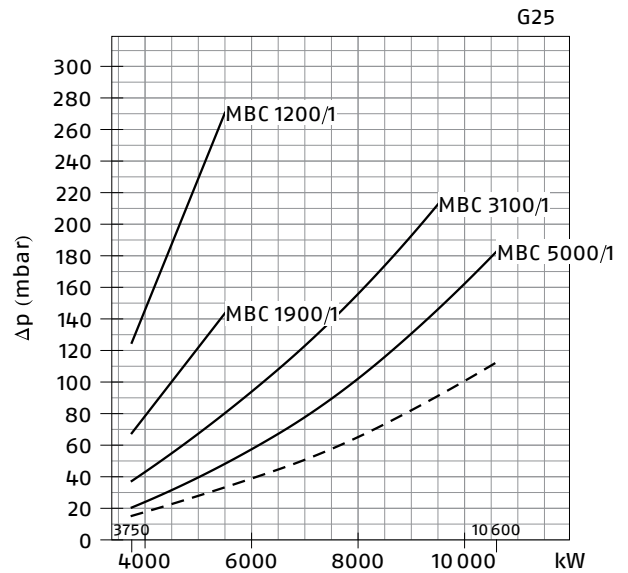
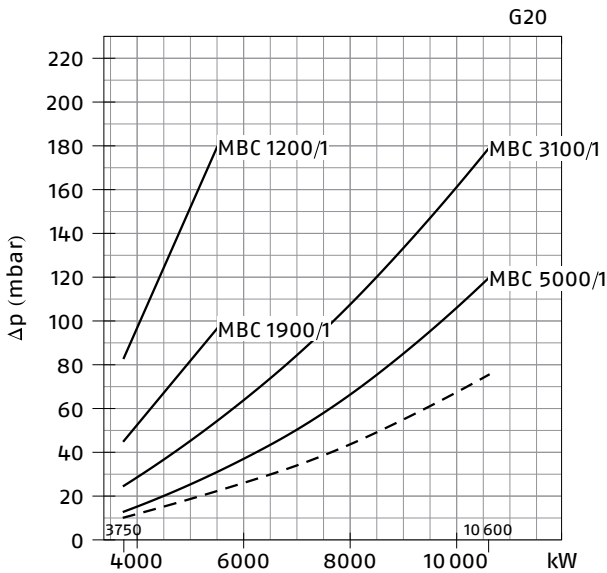

— Combustion head + gas butterfly valve + gas train  
 - - - Combustion head + gas butterfly valve



**RLS 1000/M C13 (NATURAL GAS)**

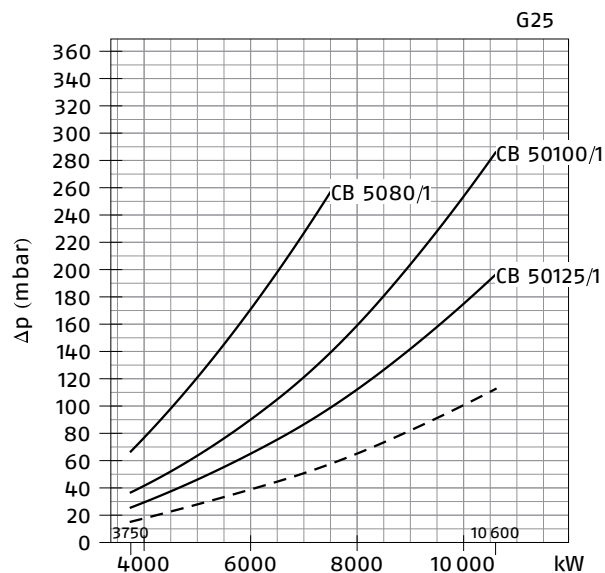
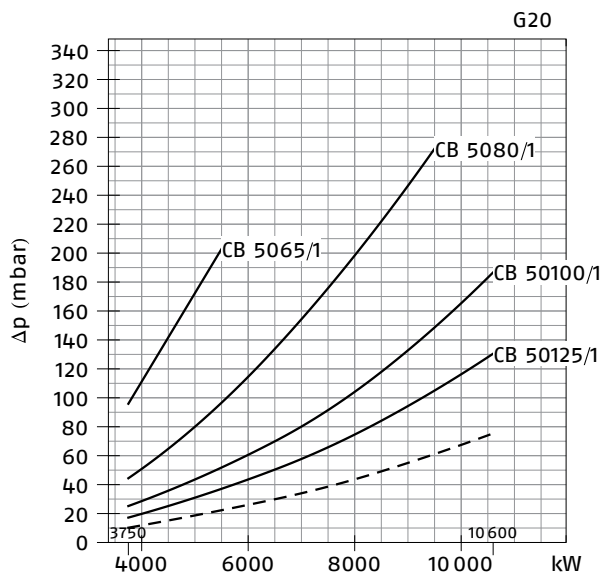

**RLS 1000/M C13 (NATURAL GAS)**

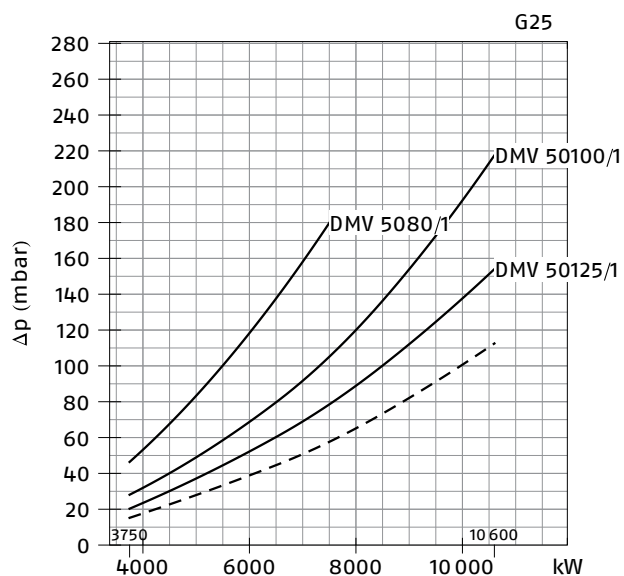
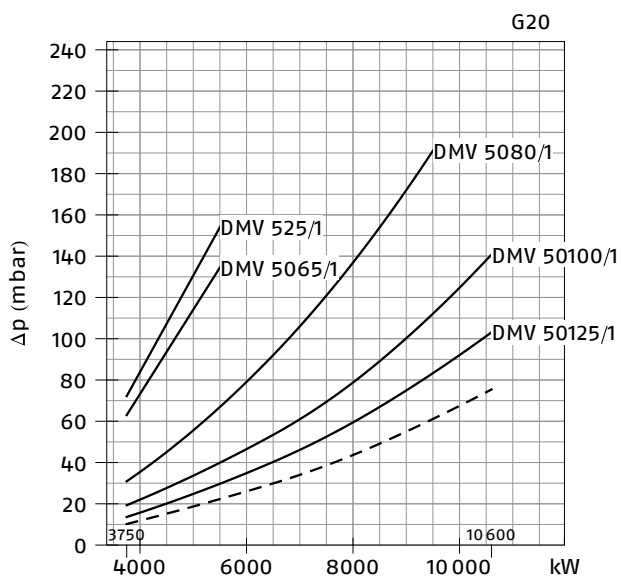

— Combustion head + gas butterfly valve + gas train  
 - - - Combustion head + gas butterfly valve

RLS 1200/M C13 (NATURAL GAS)

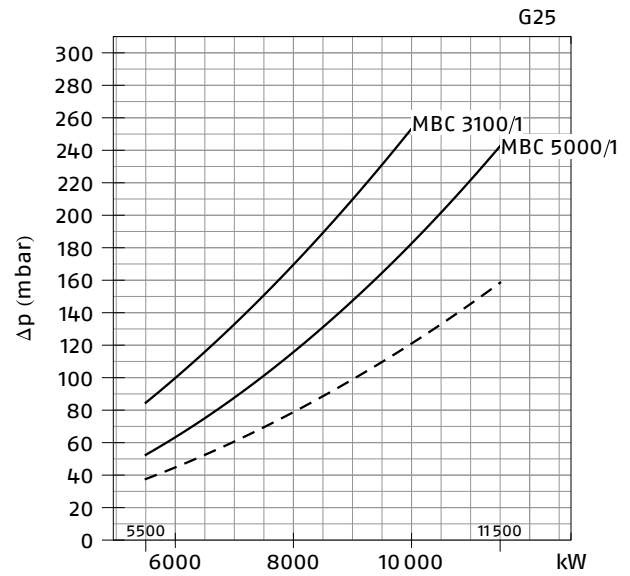
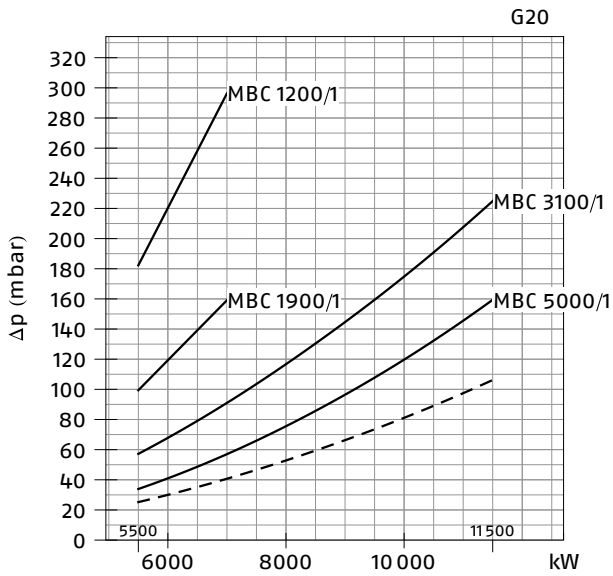

RLS 1200/M C13 (NATURAL GAS)

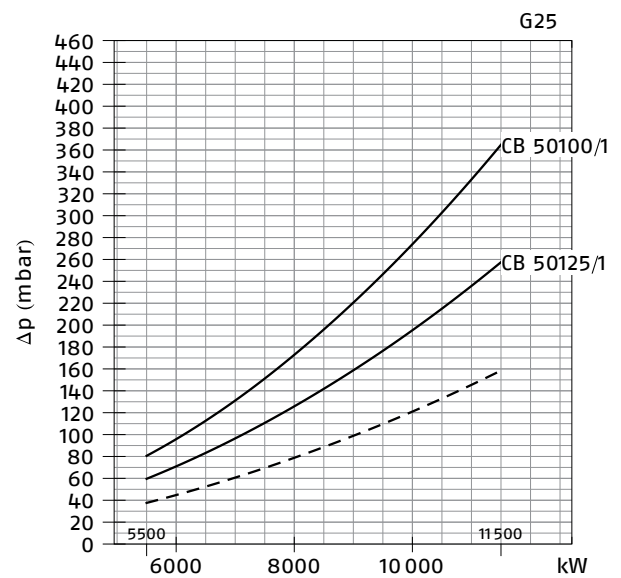
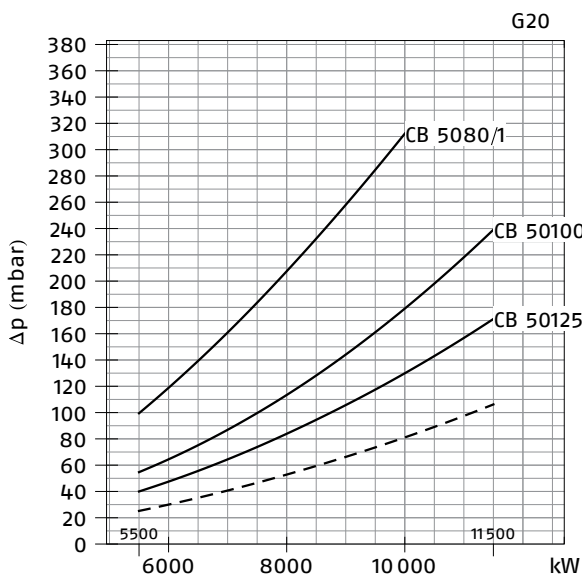

— Combustion head + gas butterfly valve + gas train  
 - - - Combustion head + gas butterfly valve

**RLS 1200/M C13 (NATURAL GAS)**

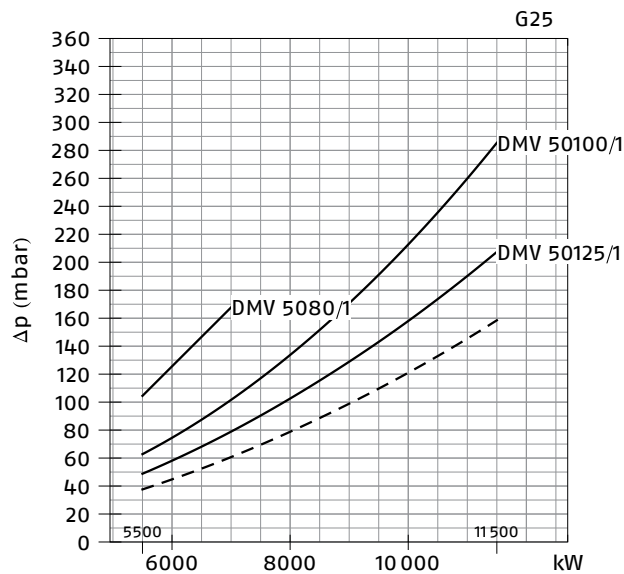
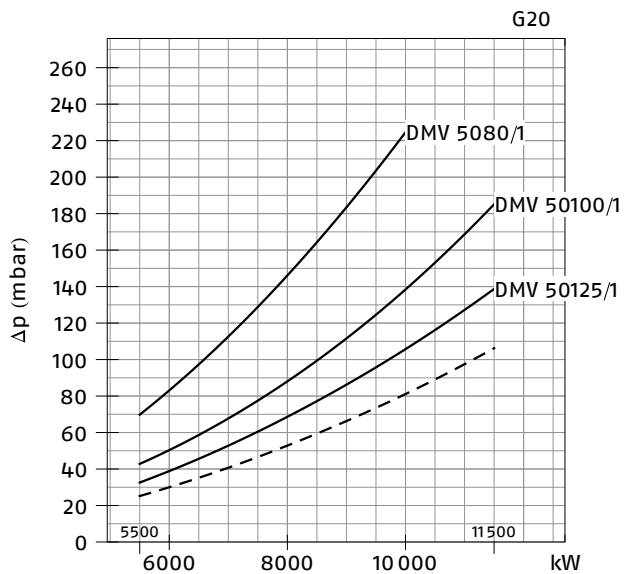

- Combustion head + gas butterfly valve + gas train
- - - Combustion head + gas butterfly valve

## Gas Trains

CODE	GAS TRAIN MODEL	Ø	C.T.	VPS CODE	ADAPTER CODE		
					RLS 500	RLS 650	RLS 800
3970221	MBC 1200/1 - RSM 60	Rp 2"	-	3010367	3000826 + 20042324		
3970225	MBC 1200/1 CT RSM 60	Rp 2"	◆	-	3010221 - 3010369		
3970222	MBC 1900/1 - FSM 40	DN 65	-	3010367	3010222		
3970226	MBC 1900/1 CT FSM 40	DN 65	◆	-	3010223 - 3010370		
3970223	MBC 3100/1 - FSM 40	DN 80	-	3010367	3000826 + 20042324		
3970227	MBC 3100/1 CT FSM 40	DN 80	◆	-	●	●	●
3970224	MBC 5000/1 - FSM 80	DN 100	-	3010367	3010221 - 3010369		
3970228	MBC 5000/1 CT FSM 80	DN 100	◆	-	3010222		
3970146	CB 520/1 - RSM 30	Rp 2"	-	3010367	3010223 - 3010370		
3970160	CB 520/1 CT RSM 30	Rp 2"	◆	-	3010224		
20044659	CB 525/1 - RSM 30	Rp 2"	-	3010367	3010224		
20044660	CB 525/1 CT RSM 30	Rp 2"	◆	-	3010224		
3970147	CB 5065/1 - FSM 30	DN 65	-	3010367	3010224		
3970161	CB 5065/1 CT FSM 30	DN 65	◆	-	3010224		
3970148	CB 5080/1 - FSM 30	DN 80	-	3010367	3010224		
3970162	CB 5080/1 CT FSM 30	DN 80	◆	-	3010224		
3970149	CB 50100/1 - FSM 30	DN 100	-	3010367	3010224		
3970163	CB 50100/1 CT FSM 30	DN 100	◆	-	3010224		
20015871	CB 50125/1 - FSM 30	DN 125	-	3010367	3010224		
3970196	CB 50125/1 CT FSM 30	DN 125	◆	-	3010224		

CODE	GAS TRAIN MODEL	Ø	C.T.	VPS CODE	ADAPTER CODE	
					RLS 1000	RLS 1200
3970221	MBC 1200/1 - RSM 60	Rp 2"	-	3010367	3000826 + 20042324	
3970225	MBC 1200/1 CT RSM 60	Rp 2"	◆	-	3010221 - 3010369	
3970222	MBC 1900/1 - FSM 40	DN 65	-	3010367	3010222	
3970226	MBC 1900/1 CT FSM 40	DN 65	◆	-	3010223 - 3010370	
3970223	MBC 3100/1 - FSM 40	DN 80	-	3010367	3000826 + 20042324	
3970227	MBC 3100/1 CT FSM 40	DN 80	◆	-	●	●
3970224	MBC 5000/1 - FSM 80	DN 100	-	3010367	3010221 - 3010369	
3970228	MBC 5000/1 CT FSM 80	DN 100	◆	-	3010222	
3970146	CB 520/1 - RSM 30	Rp 2"	-	3010367	3010223 - 3010370	
3970160	CB 520/1 CT RSM 30	Rp 2"	◆	-	3010224	
20044659	CB 525/1 - RSM 30	Rp 2"	-	3010367	3010224	
20044660	CB 525/1 CT RSM 30	Rp 2"	◆	-	3010224	
3970147	CB 5065/1 - FSM 30	DN 65	-	3010367	3010224	
3970161	CB 5065/1 CT FSM 30	DN 65	◆	-	3010224	
3970148	CB 5080/1 - FSM 30	DN 80	-	3010367	3010224	
3970162	CB 5080/1 CT FSM 30	DN 80	◆	-	3010224	
3970149	CB 50100/1 - FSM 30	DN 100	-	3010367	3010224	
3970163	CB 50100/1 CT FSM 30	DN 100	◆	-	3010224	
20015871	CB 50125/1 - FSM 30	DN 125	-	3010367	3010224	
3970196	CB 50125/1 CT FSM 30	DN 125	◆	-	3010224	

- C.T.** Gas valve leak detection control device:  
 - gas train not equipped with leak detection control device; this device can be ordered separately - see VPS column - and installed later.  
 ◆ gas train equipped with leak detection control device.
- VPS** Valve leak detection control device. Supplied separately from the gas train, on demand.
- Gas train not available or not suitable for the matching to the burner.

## Hydraulic circuits

The hydraulic circuit of the RLS/M series of burners is characterised by a fuel pump with an independent motor.

The burners are fitted with two valves (a safety valve and an operation valve) and an oil filter along the oil line from the pump to the nozzle.

A pressure regulator on the return circuit from the nozzle enables the quantity of fuel burnt to be varied. Two safety valves on the return circuit avoid oil leakage from the nozzle when the burner is in stand-by and prepurge phase.

The models are fitted with a maximum pressure switch on the oil return circuit, and a minimum oil pressure switch on the oil line from the pump to the nozzle.

The burner is suitable for continuous operation.



Example of the RLS 500-800/M burner hydraulic circuit

P	Pump with filter and pressure regulator
P0 min	Min. oil pressure switch on the delivery circuit
VF	Operating valve
VS	Safety valve on the delivery circuit
MM	Pressure gauge on the delivery circuit
NL	Nozzle pipe
U	Nozzle
MR	Pressure gauge on the return circuit
SM	Servomotor
R0	Pressure regulator on the return circuit
P0 max	Max. oil pressure switch on the return circuit
VR	Safety valve on the return circuit
VR1	Safety valve on the return circuit

### EN 267 > 100 Kg/h - RLS 500 - 650 - 800/M

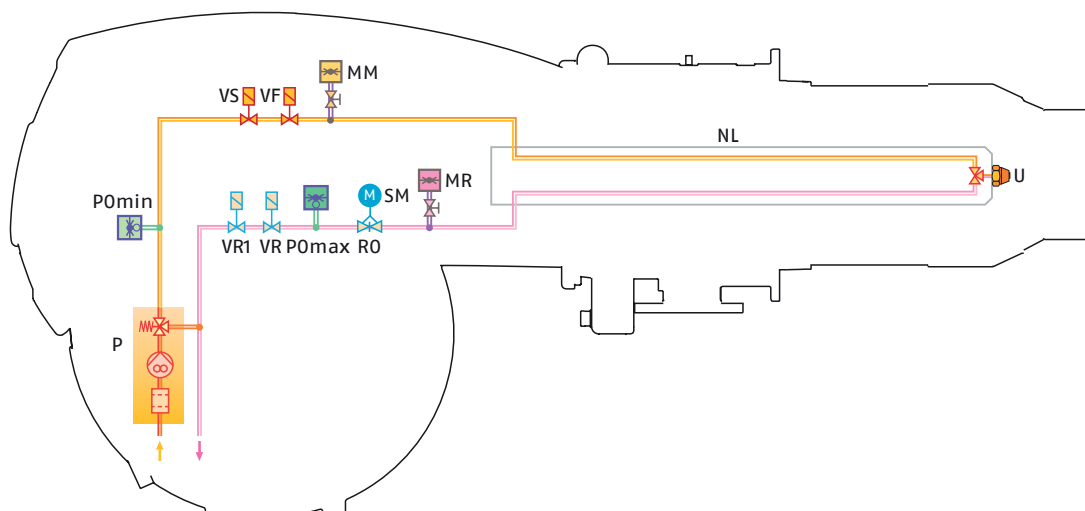

The RLS 1000-1200/M burners are equipped with a spray lance for light oil activated by compressed air.

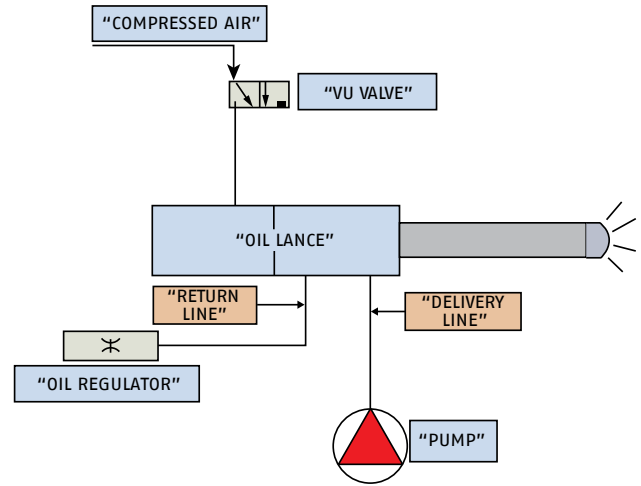

Example of light oil pump

**RLS 1000 - 1200/M**

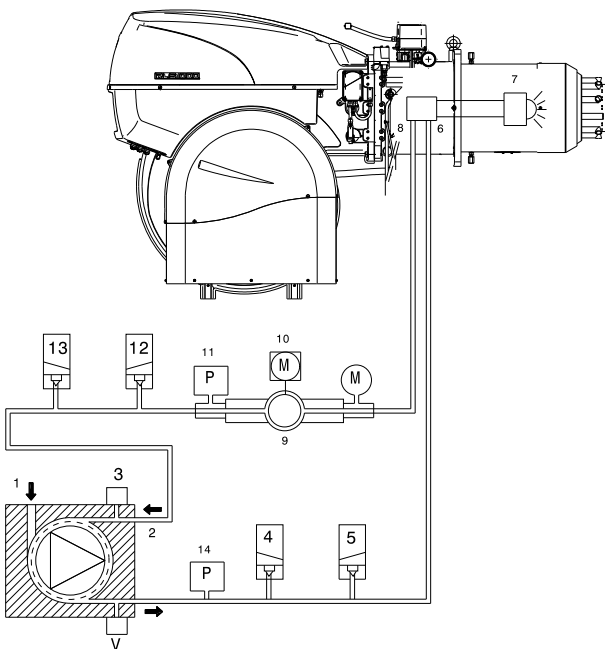

1	Pump suction
2	Pump return line and nozzle return line
3	Pump pressure regulator
4	Delivery safety valve
5	Delivery safety valve
6	Nozzle delivery line
7	Nozzle without interception rod
8	Nozzle return line
9	Pressure variator on nozzle return line
10	Pressure variator servomotor
11	Pressure switch on nozzle return line
12	Safety valve on nozzle return line
13	Safety valve on nozzle return line
14	Pressure switch on pump delivery line
M	Pressure gauges
V	Vacuometer connection

## Selecting the fuel supply lines

The fuel feed must be completed with the safety devices required by the local norms.

The table shows the choice of piping diameter, depending on the difference in height between the burner and the tank and their distance.

### MAXIMUM EQUIVALENT LENGTH FOR THE PIPING L [m]

MODEL	RLS 500-650-800/M			
DIAMETER PIPING	∅ 10 mm	∅ 12 mm	∅ 14 mm	∅ 16 mm
+/- H [m]	L max (m)			
4.0	14	30	55	95
3.5	13	28	52	89
3.0	12	26	48	82
2.5	11	24	44	76
2.0	10	22	41	70
1.5	9	20	37	63
1.0	8	18	33	57
0.5	7	16	29	51
0	6	14	26	44
-0.5	5	12	22	38
-1.0	4	10	18	32
-1.5	3	8	15	25
-2.0	-	6	11	19
-2.5	-	4	7	13
-3.0	-	-	4	7

MODEL	RLS 1000/M C13				RLS 1200/M C13			
DIAMETER PIPING	∅ 20 mm	∅ 22 mm	∅ 24 mm	∅ 27 mm	∅ 22 mm	∅ 24 mm	∅ 27 mm	∅ 36 mm
+/- H [m]	L max (m)				L max (m)			
4.0	26	45	73	138	19	33	65	300
3.0	22	39	63	120	16	28	55	260
2.0	18	33	53	102	13	23	45	220
1.0	15	26	44	84	10	18	38	185
0.5	13	23	39	75	9	16	33	165
0	11	20	34	66	7	13	30	145
-0.5	9	17	29	57	5	11	25	125
-1.0	7	14	24	48	-	9	20	108
-2.0	-	7	14	30	-	-	11	70
-3.0	-	-	-	12	-	-	-	30
-4.0	-	-	-	-	-	-	-	-

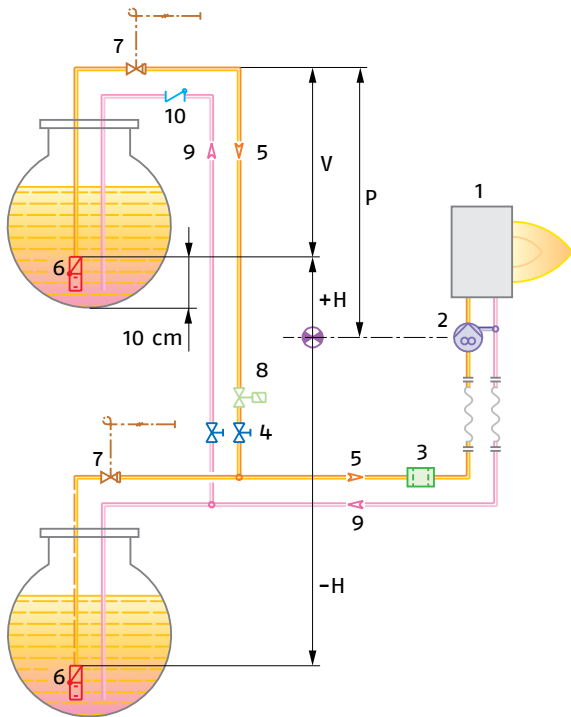

H	Pump/Foot valve height difference
L	Piping length
∅	Inside pipe diameter
1	Burner
2	Pump
3	Filter
4	Manual on/off valve
5	Suction line
6	Foot valve
7	Quick closing manual valve with remote control (Italy only)
8	On/off solenoid valve (Italy only). See electrical layout. Connections to be carried out by the installer (SV).
9	Return line
10	Check valve (only Italy)

With ring distribution oil systems, the feasible drawings and dimensioning are the responsibility of specialised engineering studios, who must check compatibility with the requirements and features of each single installation.

## Ventilation

The ventilation unit comes with a sound proofing system. All the burners in the RLS 500-650-800-1000-1200/M series are fitted with fans, which give excellent performance and are fitted in line with the combustion head. The air flow and sound-deadening materials used in the construction are designed to reduce sound emissions to the minimum and guarantee high levels of performance in terms of output and air pressure. A high precision servomotor through the main management module installed on each burner of RLS 500-650-800-1000-1200/M series, controls the air dampers position constantly.



Example of the RLS 1000-1200/M sound proofing system.



## Combustion Head

The innovative combustion head adjustment system ensures perfect movement during modulation as well as reducing noise and pollutants. Simple adjustment of the combustion head allows to adapt internal geometry of the head to the output of the burner.

The same adjustment servomotor for the air damper also varies, depending on the required output, the setting of the combustion head, through a simple lever.

This system guarantees excellent mix on all firing rates range.



Example of a RLS 500/M MX burner combustion head

### DIMENSIONS OF THE COMBUSTION CHAMBER

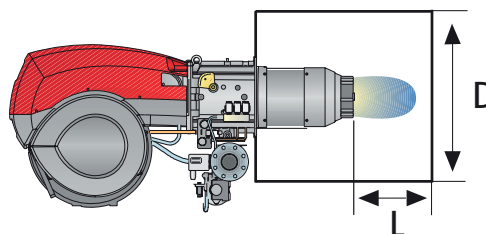
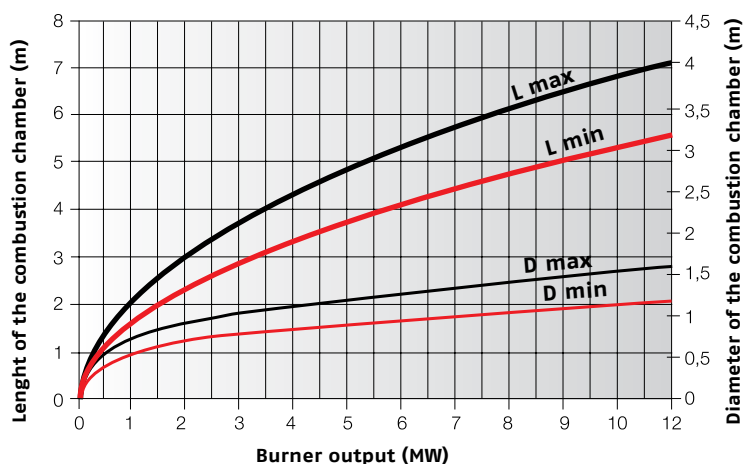

**Example:**  
 Burner thermal output = 3500 kW;  
 L combustion chamber (m) = 3,5 m (medium value);  
 D combustion chamber (m) = 1,5 m (medium value).

## Safe and Green

The RLS/M series combustion head reduce polluting emissions thanks to their special design which optimises the air fuel mix.

In the RLS/M series part of the gas is distributed through outlets which the remaining gas is injected directly into the centre of the flame.

This prevents no homogeneous concentrations in the flame with areas of high oxidation, producing very stable flame with gradual and progressive combustion as the flame develops, thus giving polluting emission values below even the most restrictive norm values.

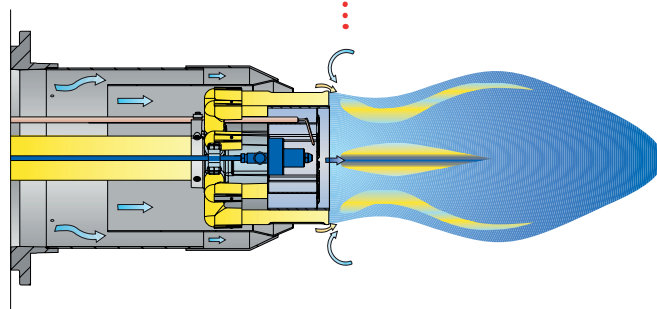

Combustion head operating diagram of RLS/M series

# Operation

## BURNER OPERATION MODE

The RLS 500-650-800-1000-1200/M series of burners can have "two-stage progressive" or "modulating" operation.



Output regulator

Analog 4-20 mA or 0 - 10V converter for remote modulation

On "two-stage progressive" operation, the burner gradually adapts the output to the requested level, by varying between two pre-set levels (see picture A).

On "modulating" operation, normally required in steam generators, in superheater boilers or diathermic oil burners, a specific regulator and probes are required. These are supplied as accessories that must be ordered separately. The burner can work for long periods at intermediate output levels (see picture B).

### "TWO-STAGE PROGRESSIVE" OPERATION

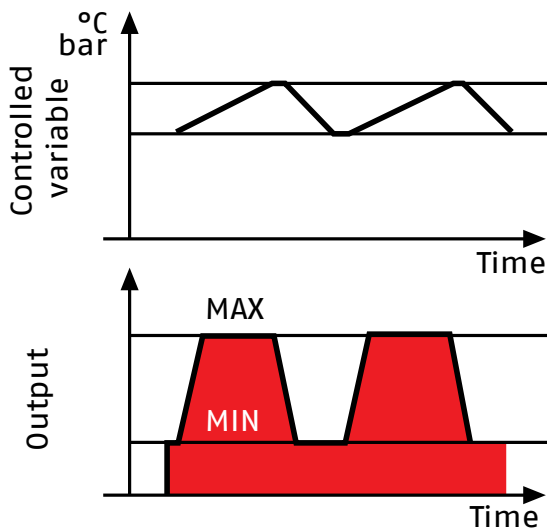

Picture A

### "MODULATING" OPERATION

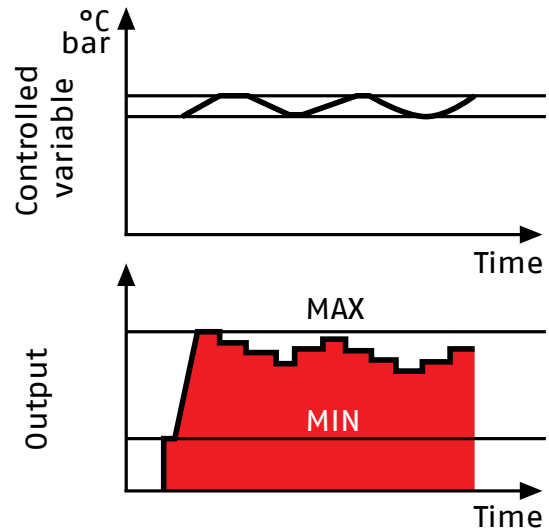

Picture B

The RLS 500-650-800-1000-1200/M series burners are fitted with the LFL1...control panel. The FS2 burners are on demand and fitted with the LGK control panel.



**LFL ... CONTROL BOX**



**LGK ... CONTROL BOX**

# Emission

NO2 EMISSIONS (gas G20)

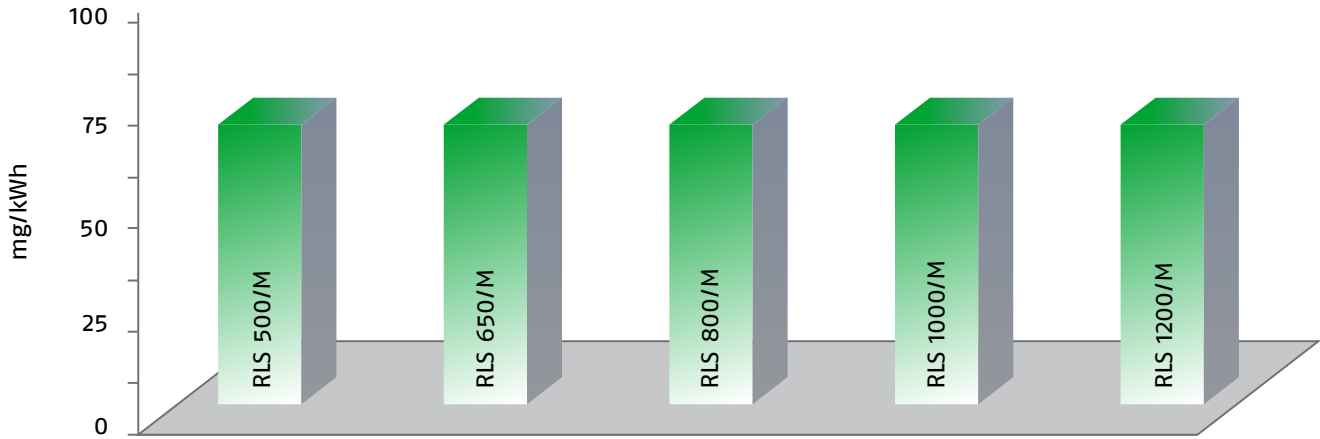

CO EMISSIONS (gas G20)

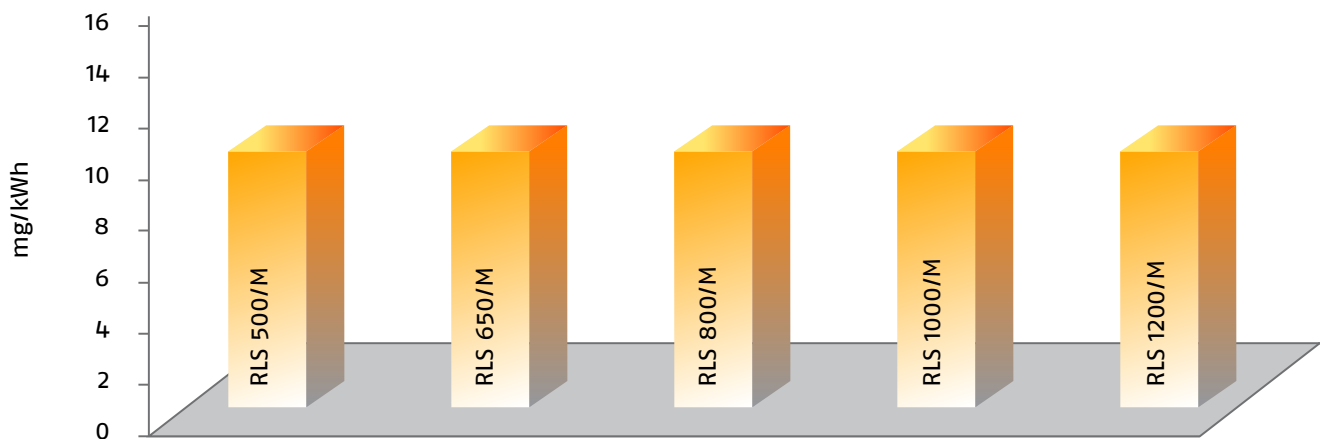

NOISE EMISSIONS

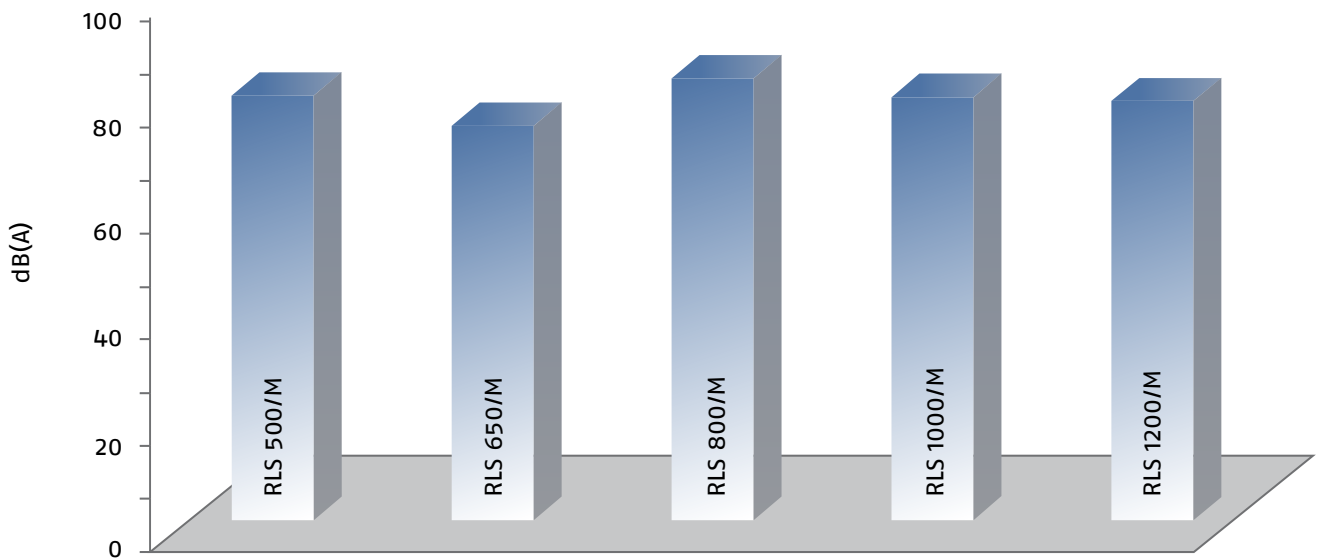

The noise emissions have been measured at the maximum output.

## Overall Dimensions (mm)

BURNERS (RLS 500-650-800/M)

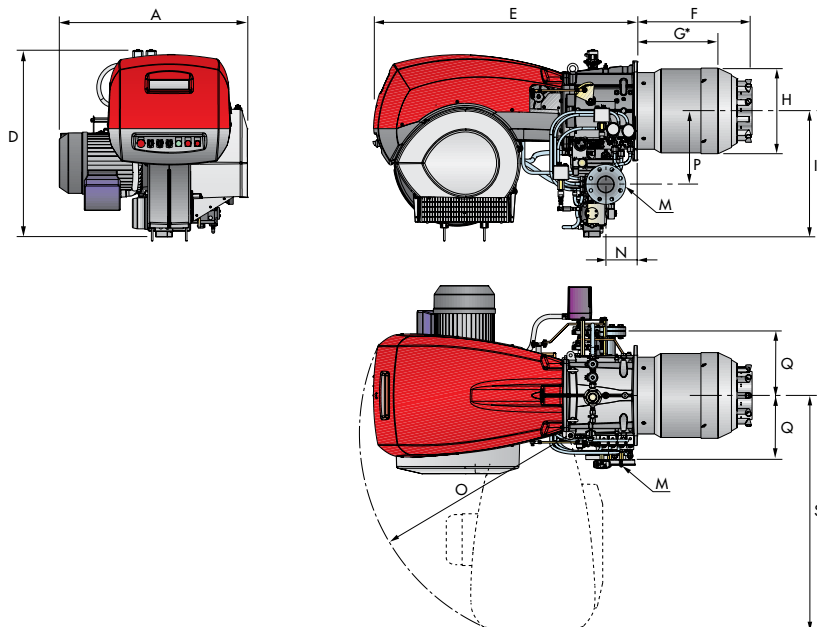

MODEL	A	D	E	F	G*	H	I	M	N	O	P	Q	S
RLS 500/M	900	890	1325	544	390	370	605	DN80	164	1055	342	320	1175
RLS 650/M	880	950	1325	562	360	410	630	DN80	164	1055	427	320	1190
RLS 800/M	940	937	1325	558	382	428	630	DN80	164	1055	427	320	1190

\* Maximum depth of the boiler door including the depth of the burner flange insulating gasket.

### BURNER - BOILER MOUNTING FLANGE

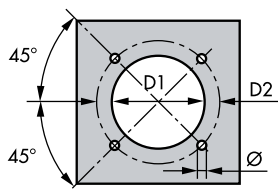

MODEL	D1	D2	Ø
RLS 500/M	390	452	M18
RLS 650/M	440	495	M18
RLS 800/M	440	495	M18

### PACKAGING

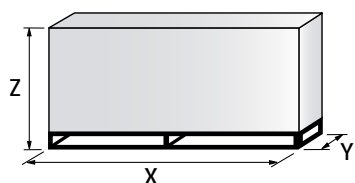

MODEL	X	Y	Z	kg
RLS 500/M	1960	970	1100	280
RLS 650/M	2190	1110	1450	320
RLS 800/M	2190	1110	1450	320

**BURNER (RLS 1000-1200/M)**

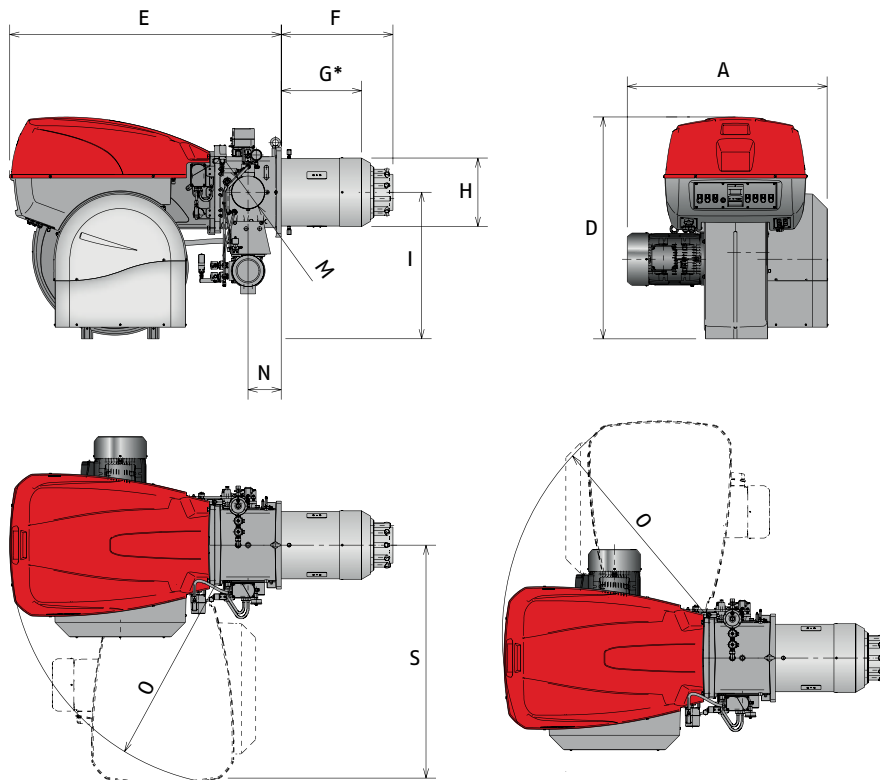

MODEL	A	D	E	F	G*	H	I	M	N	O	S
RLS 1000/M	1206	1338	1637	674	484	413	885	DN80	200	1350	1425
RLS 1200/M	1250	1338	1637	658	465	456	885	DN80	200	1350	1425

\* Maximum depth of the boiler door including the depth of the burner flange insulating gasket.

**BURNER - BOILER MOUNTING FLANGE**

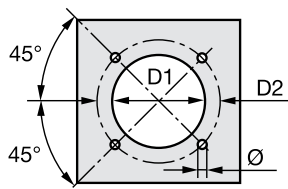

MODEL	D1	D2	Ø
RLS 1000/M	460	608	M20
RLS 1200/M	500	608	M20

**PACKAGING**

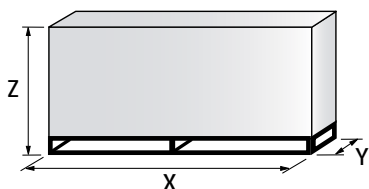

MODEL	X	Y	Z	kg
RLS 1000/M	2400	1400	1595	500
RLS 1200/M	2400	1400	1595	500

## Burner accessories

### NOZZLES

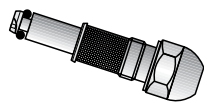

Return nozzles without needle are used on RLS/M MX burners. The nozzle must be ordered as accessory. The following table shows the features and codes on the basis of the maximum required fuel output.

BURNER	NOZZLE TYPE	RATED DELIVERY (kg/h)	NOZZLE CODE
RLS 500/M	N2	350	3045495
RLS 500/M	N2	400	3045499
RLS 500/M	N2	450	3045501
RLS 500/M	N2	500	3045503
RLS 650/M	N2	350	3045495
RLS 650/M	N2	450	3045501
RLS 650/M	N2	550	3045505
RLS 650/M	N2	600	3045507
RLS 800/M	B5 SA 45°	375	3009332
RLS 800/M	B5 SA 45°	550	3009346
RLS 800/M	B5 SA 45°	650	3009352
RLS 800/M	B5 SA 45°	750	3009356
RLS 1000/M	B5 AA 60°	350	20047954
RLS 1000/M	B5 AA 60°	600	20047978
RLS 1000/M	B5 AA 60°	750	20047985
RLS 1000/M	B5 AA 60°	900	20047994
RLS 1200/M	CT5 60°	700	20006479
RLS 1200/M	CT5 60°	700	20006479
RLS 1200/M	CT5 60°	900	20006482
RLS 1200/M	CT5 60°	1100	20006484

### ACCESSORIES FOR MODULATING OPERATION

#### POWER CONTROLLER



To obtain modulating operation, the RLS/M MX series of burners requires a regulator.

BURNER	REGULATOR TYPE	REGULATOR CODE
All models	RWF 50.2	20101190
All models	RWF 55.5	20101191

#### PROBE



The relative temperature or pressure probes fitted to the regulator, must be chosen on the basis of the application.

BURNER	PROBE TYPE	RANGE (°C) (bar)	PROBE CODE
All models	Temperature PT 100	-100 ÷ 500°C	3010110
All models	Pressure 4 ÷ 20 mA	0 ÷ 2,5 bar	3010213
All models	Pressure 4 ÷ 20 mA	0 ÷ 16 bar	3010214
All models	Pressure 4 ÷ 20 mA	0 ÷ 25 bar	3090873

**ANALOG CONTROL SIGNAL CONVERTER**



BURNER	TYPE (INPUT SIGNAL)	CODE
All models	0/2 - 10 V (impedance 200 KΩ) 0/4 - 20 mA (impedance 250 Ω)	3010390

**POTENTIOMETER**



BURNER	KIT CODE
RLS 500-650-800/M	3010402
RLS 1000-1200/M	on demand

It is necessary for analogic control signal converter operation.

**FUEL REMOTE SELECTION KIT**



BURNER	KIT CODE
RLS 500-650-800-1000-1200/M	3010372

**SOUND PROOFING BOX**

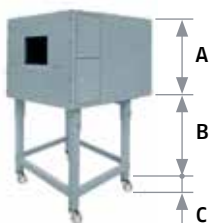

If noise emission needs reducing even further, sound-proofing boxes are available.

In case of generator heights, where a lower dimension "B" is required, ask for the Box Support Kit code 20065135.

BURNER	BOX TYPE	A (mm)	B (mm) min-max	C (mm)	[dB(A)] (*)	BOX CODE
RLS 500-650-800/M	C7	1255	160 - 980	110	10	3010376
RLS 1000-1200/M	C8	1425	285 - 1000	110	10	3010401

(\*) Average noise reduction according to EN 15036-1 standard

**SPACER KIT**



If burner head penetration into the combustion chamber needs reducing, varying thickness spacers are available, as given in the following table:

BURNER	SPACER THICKNESS S (mm)	KIT CODE
RLS 500-650-800/M	180	20008903







## Gas train accessories

### ADAPTERS

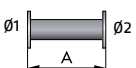
In certain cases, an adapter must be fitted between the gas train and the burner, when the diameter of the gas train is different from the set diameter of the burner.

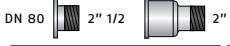
Below are given the available adapters; please see on the Gas Train list the correct adapter codes to select.

ADAPTER	DIMENSIONS					ADAPTER CODE
	$\varnothing i$ DN	$\varnothing O$ DN	A mm	B mm	C mm	
	65	80	400	-	-	3010221
	80	80	400	-	-	3010222
	100	80	400	-	-	3010223
	125	80	320	-	-	3010224
	65	80	10	-	-	3010369
	100	80	50	-	-	3010370
	-	-	35	-	-	3000843
	-	-	300	-	-	3000826
	-	-	65	-	-	20042324

### STABILISER SPRING



To vary the pressure range of the gas train stabilisers, accessory springs are available. The following table shows these accessories with their application range. Please refer to the technical manual for the correct choice of spring.

GAS TRAIN	SPRING COLOUR	SPRING PRESSURE RANGE mbar	SPRING CODE
MBC 1900/1 - 3100/1 MBC 5000/1	White	4 - 20	3010381
	Red	20 - 40	3010382
	Black	40 - 80	3010383
	Green	80 - 150	3010384
CB 5065/1-5080/1	Red	25 - 55	3010133
	Black	60 - 110	3010135
	Pink	100 - 150	3090456
	Grey	140 - 200	3090992
CB 50100/1	Red	25 - 55	3010134
	Black	60 - 110	3010136
	Pink	100 - 150	3090489
CB 50125/1	Grey	140 - 200	3092174
	Red	25 - 55	3010315
	Yellow	30 - 70	3010316
	Black	60 - 110	3010317
	Pink	100 - 150	3010318

**SEAL CONTROL KIT**



To test the valve seals on the gas train, a special "seal control kit" is available. The valve seal control device is compulsory (EN 676) on gas trains to burners with a maximum output over 1200 kW. The seal control is type VPS 504.

GAS TRAIN	KIT CODE FOR 50 Hz OPERATION	KIT CODE FOR 60 Hz OPERATION
MBC/1-CB/1-DMV/1 type	3010367	20029057

# Specification

## DESIGNATION OF SERIES

A specific index guides your choice of burner from the various models available in the RLS/M series. Below is a clear and detailed specification description of the product.

Series: R									
Fuel: S Natural Gas									
L Light oil									
LS Light oil/Natural Gas									
N Heavy oil									
Size									
Setting : /1 Single stage					/E Electronic cam				
/B Two stage					/P Proportioning air/gas valve				
/M Modulating - Mechanical cam					/EV Electronic cam predisposed for variable speed (with inverter)				
Emission :									
C11 or ...			Class 1 EN267 - EN676						
C22 or MZ			Class 2 EN267 - EN676						
C33 or BLU			Class 3 EN267 - EN676						
C23 or MX			Class 2 EN267 - Class 3 EN676						
C13			Class 1 EN267 - Class 3 EN676						
Head length:									
TC standard head					TL extended head				
Flame control system:									
FS1 Standard (1 stop every 24 h)					FS2 Continuous working (1 stop every 72 h)				
Electrical supply to the system:									
1/230/50					1/230V/50Hz				
3/230/50					3/230V/50Hz				
3/400/50					3N/400V/50Hz				
3/230-400/50					3/230V/50Hz - 3N/400V/50Hz				
3/220/60					3/220V/60Hz				
3/380/60					3N/380V/60Hz				
3/220-380/60					3/220/60Hz - 3N/380V/60Hz				
Auxiliary voltage:									
230/50-60					230V/50-60Hz				
110/50-60					110V/50-60Hz				

R	LS	1000	/M	C13	TC	FS1	3/400/50	230/50-60	
BASIC DESIGNATION					EXTENDED DESIGNATION				

## AVAILABLE BURNER MODELS

BURNER MODELS	HEAD LENGHT	FLAME CONTROL SYSTEM	ELECTRICAL SUPPLY	AUXILIARY VOLTAGE
RLS 500/M MX	TC	FS1	3/400/50	230/50-60
RLS 650/M MX	TC	FS1	3/400/50	230/50-60
RLS 800/M MX	TC	FS1	3/400/50	230/50-60
RLS 1000/M C13	TC	FS1	3N/400/50	230/50-60
RLS 1200/M C13	TC	FS1	3N/400/50	230/50-60

## PRODUCT SPECIFICATION

### Burner

Monoblock forced draught dual fuel burner with modulating operation, fully automatic, made up of:

- High performance fan
- Air suction circuit lined with sound-proofing material
- Air damper for air setting controlled by a high precision servomotor
- Air pressure switch
- Fan starting motor at 2800 rpm, three-phase, 400V, 50Hz
- Low emission combustion head, that can be set on the basis of required output, fitted with:
  - stainless steel end cone, resistant to corrosion and high temperatures
  - ignition electrodes for RLS 500
  - ignition by gas pilot with gas train for RLS 650 - 800 - 1000 - 1200 models
  - flame stability disk
- Mechanical cam with gas and oil modulator
- Maximum gas pressure switch, with pressure test point, to stop the burner in the case of over pressure on the fuel supply line
- Flame control panel for controlling the system safety - Infrared flame detector
- Star/triangle starter for the fan motor - Main electrical supply terminal board
- Burner on/off switch
- Auxiliary voltage led signal
- Burner working led signal
- Contacts motor and thermal relay with release button
- Motor internal thermal protection
- Motor failure led signal
- Burner failure led signal and lighted release button
- Emergency button
- Connection plugs-sockets
- Burner opening hinge
- Lifting rings
- IP 54 electric protection level
- Light oil gears pump for high pressure fuel supply
- Dedicated pump starting motor
- Valve system with double oil safety valve on the output circuit and double safety valve on the return circuit
- Maximum an minimum oil pressure switches
- Oil pressure gauges on supply and return oil lines
- Oil/Gas selector
- Flame inspection window
- The RLS 1000-1200/M dual fuel burners are equipped with a spray lance for light oil, activated by compressed air (air compressor not included).

**Standard equipment:**

- 1 flange gasket
- 4 screws for fixing the flange
- 1 thermal screen
- 4 screws for fixing the burner flange to the boiler
- 2 flexible pipes for connection to the oil supply network
- 2 nipples for connection to the pump with gaskets
- Seal control pressure switch (for installation on gas train)
- Instruction handbook for installation, use and maintenance
- Spare parts catalogue.

**Gas train**

Fuel supply line, in the MULTIBLOC configuration (for a diameter of 1-1/2" and 2") or COMPOSED configuration (from a diameter of DN 65 until a diameter of DN 125), fitted with:

- Filter
- Stabiliser
- Minimum gas pressure switch
- Safety valve
- One stage working valve with ignition gas output regulator.

**Conforming to:**

- 2004/108 EC directive (electromagnetic compatibility)
- 2006/95 EC directive (low voltage)
- 2006/42 EC directive (machine)
- 2009/142 EC directive (gas)
- EN 676 (gas burners)
- EN 267 (light oil burners).

**Available accessories to be ordered separately:**

- RWF 50 power controller
- Temperature probe -100/+500 °C
- Pressure probe 0-2.5 bar
- Pressure probe 0-16 bar
- Pressure probe 0-25 bar
- Analog control signal converter
- Potentiometer kit for servomotor
- Continuous ventilation kit
- UV cell kit
- PC interface kit
- Sound proofing box
- Spacer
- Adapters
- Stabiliser spring
- Seal control.





# Riello Burners a world of experience in every burner we sell.



[ 1 ]

Across the world, Riello sets the standard in reliable and high efficiency burner technology.

With burner capacity from 5 kW to 48 MW, Riello gas, oil, dual fuel and Low Nox burners deliver unbeatable performance across the full range of residential and commercial heating applications, as well as in industrial processes.

With headquarter in Legnago, Italy, Riello has been manufacturing premium quality burners for over 90 year. The manufacturing plant is equipped with the most innovative systems of assembling lines and modern manufacturing cells for a quick and flexible response to the market.



[ 2 ]

Besides, the Riello Combustion Research Centre, located in Angiari, Italy, represents one of the most modern facility in Europe and one of the most advanced in the world for the development of the combustion technology.

Today, the company's presence on worldwide markets is distinguished by a well-constructed and efficient sales network, alongside many important Training Centres located in various countries to meet its customers' needs. Riello has 13 operational branches abroad (in Europe, America and Asia), with customers in over 60 countries.

[ 1 ] BURNERS PRODUCTION PLANT  
S. PIETRO, LEGNAGO (VERONA) - ITALIA

[ 2 ] HEADQUARTER BURNERS DIVISION  
S. PIETRO, LEGNAGO (VERONA) - ITALIA

RIELLO S.p.A. - 37045 Legnago (VR) - Italy  
tel. +39 0442 630111 - fax: +39 0442 21980  
[www.riello.com](http://www.riello.com)

Since the Company is constantly engaged in the production improvement, the aesthetic and dimensional features, the technical data, the equipment and the accessories can be changed. This document contains confidential and proprietary information of RIELLO S.p.A. Unless authorised, this information shall not be divulged, nor duplicated in whole or in part.

# RIELLO