

GasMultiBloc® Combined regulator and safety shut-off valves Two-stage function

MB-ZRD(LE) 415 - 420 B01

DUNGS®
Combustion Controls

7.26

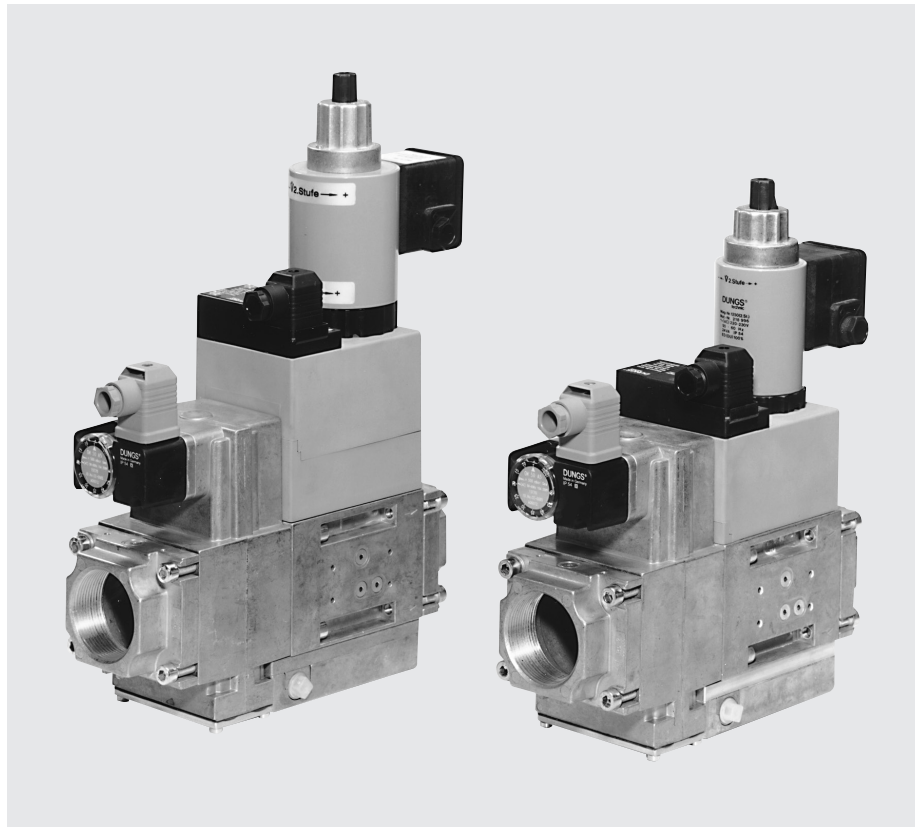

Technical description

The DUNGS GasMultiBloc® integrates filter, regulator, valves and pressure switches in one compact fitting.

- Dirt trap: microfilter
- One regulator and two main valves: B01
- One one-stage valve and one two-stage valve
- One valve is fast opening, one valve is slow or fast opening
- Solenoid valves up to 360 mbar (36 kPa) as per DIN EN 161 Class A Group 2
- Sensitive setting of output pressure by proportional regulator as per DIN EN 88 Class A Group 2
- High flow rates with low pressure drop
- DC solenoid drive interference degree N
- Main volume restrictor and partial volume restrictor at valve V2
- Hydraulic opening delay
- Flange connections with pipe threads as per ISO 7/1
- Simple mounting, compact, light-weight

The modular system permits individual solutions by using external ignition gas tap in connection with separately controlled valves, by adding a valve proving system, mini/maxi pressure switches, pressure limiters, limit switch at valve V2.

Application

The modular system permits individual solutions in gas safety and regulator engineering. Suitable for gases of families 1, 2, 3 and other neutral gaseous media.

Approvals

EC type test approval as per EC Gas Appliance Directive:
MB-ZR...415-420 B01 CE-0085 AP 3156

EC type test approval as per EC Pressure Equipment Directive:
MB-ZR...415-420 B01 CE0036

Approvals in other important gas consuming countries.

Functional description of gas flow

1. When the valves V1 and V2 are closed, chamber A is under inlet pressure.
2. A hole D in the filter housing connects min. pressure switch with chamber A. If the inlet pressure applied to the pressure switch exceeds the incoming reference value, it switches through to the automatic burner control.
3. After release by the automatic burner control, valves V1 and V2 open. The gas flows through chambers A, B and C of the GasMultiBloc.
4. On request, the second stage of valve V2 opens.

Operating method of valve-regulator combination on valve V1

A regulator, compensating for residual pressure is integrated in valve V1 (pressure regulating part). Armature 8 is not connected to valve plate unit 3. When it opens, armature 8 pretensions compression spring (V1) 5 and releases the valve plate unit. When the valve closes, the armature acts directly on the valve plate unit. The output pressure upstream of valve V2 is defined by pretensioning regulating spring 7 (tension spring) via setting screw 18.

The output pressure acts via opening E on the working diaphragm 22 of the regulator part. In regulated state, setting spring inlet pressure and pressure of working diaphragm are in force equilibrium.

The compensating diaphragm 23 ensures the fast closing function of valve V1 and a high regulating quality.

Sectional drawing of MB-ZRDLE...

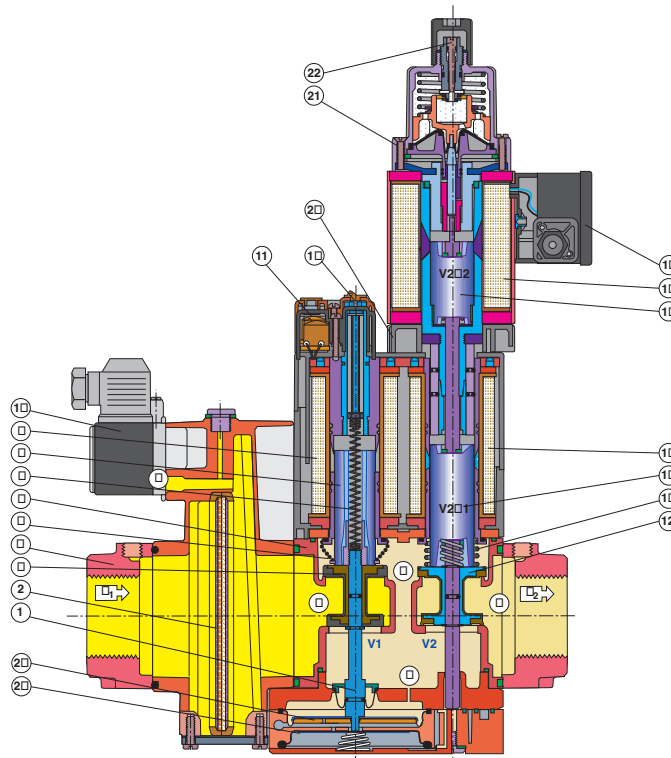

1 Pressure regulator	10 Gas pressure switch	Setting:
2 Microfilter	11 Electrical connection	19 - Gas pressure p_a
3 Valve V1	12 Valve V2	20 - Partial volume, 1st stage
4 Connection flange	13 Closing spring V2	21 - Main volume
5 Closing spring V1	14 Armature V2 (1st stage)	22 - Fast stroke
6 Housing	15 Solenoid V2 (1st stage)	23 Working diaphragm
7 Regulating spring	16 Armature V2 (2nd stage)	24 Compensation diaphragm
8 Armature V1	17 Solenoid V2 (2nd stage)	
9 Solenoid V1	18 Electrical connection	

Operating method of valve V2

Armature 14 of valve V2 is connected to valve plate unit 11. When it opens, armature 14 pretensions closing spring 13. The valve opening of stage 1 can be set by limiting the armature stroke by means of main volume restrictor 19.

Min. opening (residual stroke) of valve (0.5 to 1.0 mm)

If the second stage of valve 2 opens, closing spring 13 is continuously pretensioned. The maximum valve opening of stage 2 can be set by limiting the armature stroke of armature 16 by means of the main volume restrictor. Main volume restrictor 20 is set by rotating the adjusting plate or the hydraulic brake. The fast and/or slow opening characteristic acts on both stages. It is influenced by setting the fast stroke at the hydraulic brake under the cover.

Closing function

When the supply voltage to the solenoid coils of valves V1 and V2 is interrupted, they are closed within < 1 s by the compression springs.

Pressure taps

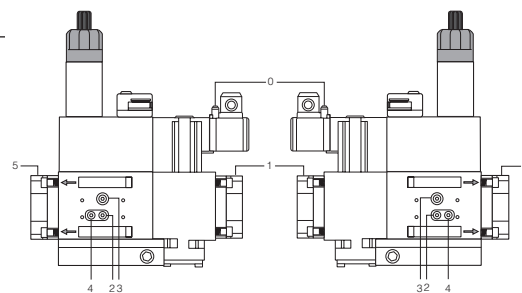
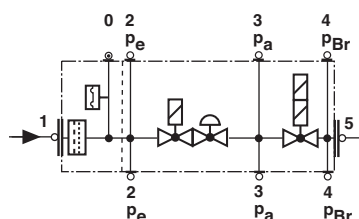

0, 1, 2, 3, 4, 5
G 1/8 screw plug

Electrical connection

S 20/S 50

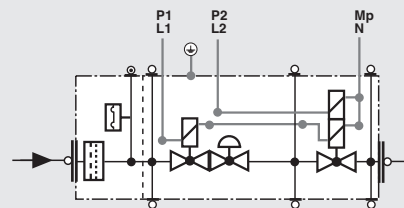
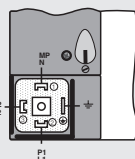

S 22/S 52

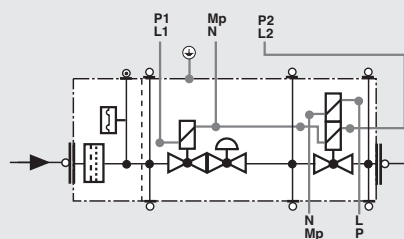
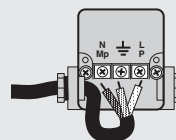
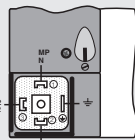

Valves V1, V2
1st stage

Valve V2
2nd stage

Specifications

Nominal diameters Flange with pipe threads as per ISO 7/1 (DIN 2999)	MB-ZR...415 B01 Rp 1, 1 1/4, 1 1/2, 2 and their combinations	MB-ZR...420 B01 Rp 1, 1 1/4, 1 1/2, 2 and their combinations																				
Max. operating pressure	360 mbar (36 kPa)																					
Output pressure ranges	MB-ZR... S20/S22 p_a: 4 mbar (0.4 kPa) to 20 mbar (2 kPa) MB-ZR... S50/S52 p_a: 20 mbar (2 kPa) to 50 mbar (5 kPa)																					
Media	Gases of families 1, 2, 3 and other neutral gaseous media																					
Ambient temperature	-15 °C to +70 °C (Do not operate MB-ZR below 0 °C in liquid gas systems. Only suitable for gaseous liquid gas, liquid hydrocarbons destroy sealing materials.)																					
Dirt trap	Sieve, microfilter, changing the filter is possible without removing the valve.																					
Pressure switches	Types GW...A5, ÜB...A2 / NB...A2 to DIN EN 1854 may be attached. For further information, refer to Datasheets 5.02 and 5.07 "Pressure Switches for DUNGS Multiple Actuators"																					
Pressure regulator	Pressure regulator compensated for residual pressure, leakproof seal when switched off by means of valve V1 as per DIN EN 88 Class A. Setpoint spring permanently installed (no spring exchange possible). A vent line above roof is not required. Internal pulse tap provided.																					
Solenoid valve V1	Valve as per DIN EN 161 Class A Group 2, fast closing, fast opening																					
Solenoid valve V2	Valve as per DIN EN 161 Class A Group 2, fast closing																					
	<table border="1"> <thead> <tr> <th></th> <th>Valve V2 design</th> <th>Partial volume restrictor</th> <th>Main volume restrictor</th> </tr> </thead> <tbody> <tr> <td>MB-ZR</td> <td>fast opening</td> <td>with</td> <td>without</td> </tr> <tr> <td>MB-ZRD</td> <td>fast opening</td> <td>with</td> <td>with</td> </tr> <tr> <td>MB-ZRDLE</td> <td>slowly opening</td> <td>with</td> <td>with</td> </tr> <tr> <td>MB-ZRLE</td> <td>slowly opening</td> <td>with</td> <td>without</td> </tr> </tbody> </table>			Valve V2 design	Partial volume restrictor	Main volume restrictor	MB-ZR	fast opening	with	without	MB-ZRD	fast opening	with	with	MB-ZRDLE	slowly opening	with	with	MB-ZRLE	slowly opening	with	without
	Valve V2 design	Partial volume restrictor	Main volume restrictor																			
MB-ZR	fast opening	with	without																			
MB-ZRD	fast opening	with	with																			
MB-ZRDLE	slowly opening	with	with																			
MB-ZRLE	slowly opening	with	without																			
Measuring / Ignition gas connection	For G 1/8 as per DIN ISO 228, refer to Pressure taps on page 2																					
Burner pressure monitor p _{Br}	Connection downstream of valve V2, pressure switch mountable on adapter laterally																					
Voltage / Frequency	50 - 60 Hz, 220 - 230 V AC, -15 % +10 % Other preferred voltages: 240 VAC, 110 - 120 VAC, 48 VDC, 24 - 28 VDC																					
Electrical connection	Plug connection as per DIN EN 175301-803 for valves and pressure switches																					
Rating / Power consumption Switch-on duration Degree of protection Radio interference	Refer to Dimensions on page 5 100 % IP 54 as per IEC 529 (EN 60529) Interference degree N																					
Materials of gas conveying parts	Housing Diaphragms, seals Solenoid drive	aluminium die casting NBR basis, Silopren (silicone rubber) steel, brass, aluminium																				
Installation position	Solenoid vertically upright or lying horizontally as well as its intermediate positions.																					
Closed position signal contact	Closed position signal contact, type K01/1 (DIN-tested), mountable to V2																					

Equipment variants GasMultiBloc®...B01 Two-stage function	415 B01	420 B01	
MB-ZR	•	•	Filter element can be removed. A suitable GF.../1 gas filter must then be fitted upstream.
MB-ZRD	•	•	
MB-ZRDLE	•	•	
MB-ZRLE	•	•	
Microfilter (standard) with sieve	•	•	
Gas pressure switch downstream of filter	•	•	
Gas pressure switch downstream of valve V2 on adapter laterally	•	•	
Pressure regulator	•	•	
Valve V1, double seat	•	•	
Valve V2, double seat	•	•	
Valves opening together	•	•	S 20, S 50
Valves opening separately	•	•	S 22, S 52
Flange Rp 1	•	•	• = possible (•) = on request - = not possible
Flange Rp 1 1/4	•	•	
Flange Rp 1 1/2	•	•	
Flange Rp 2	•	•	

MB-ZR...B01 design

- V1 = Valve 1
- V2 = Valve 2
- 3 = Filter
- 4 = Pressure switch
- 5 = Regulator

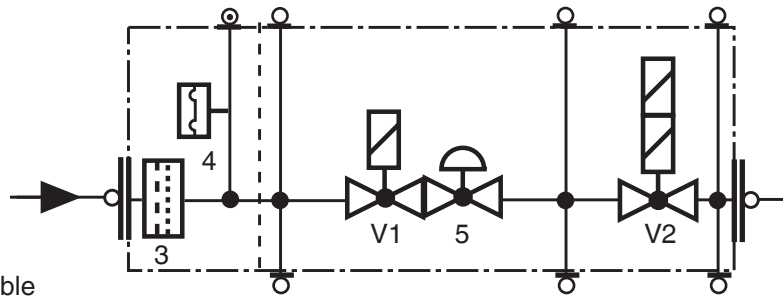

Mounting of VPS 504 valve proving system possible
Mounting of K01/1 closed position signal contact possible

Type key of MultiBloc®



Dimensions [mm]

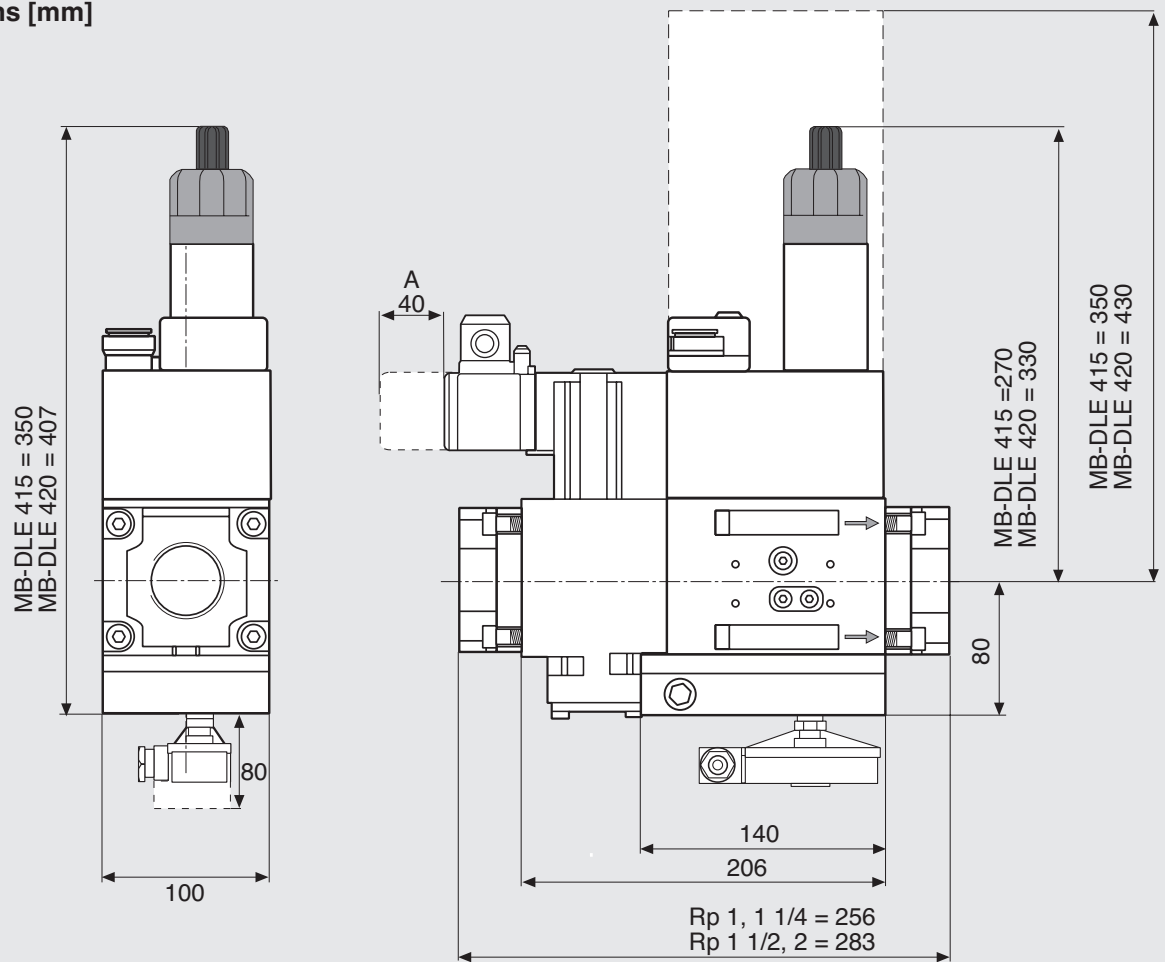

Type	Rp	Opening time	Nominal rating [VA] 230 V AC; +20 °C				Weight [kg]
			S20	S50	S22	S52	
MB-ZRD 415 B01	Rp 1 - 2	< 1 s	80	80	120	120	8.0
MB-ZRDLE 415 B01	Rp 1 - 2	< 20 s	80	80	120	120	8.1
MB-ZRD 420 B01	Rp 1 - 2	< 1 s	115	115	135	135	10,1
MB-ZRDLE 420 B01	Rp 1 - 2	< 20 s	115	115	135	135	10.2

GasMultiBloc®
Combined regulator and
safety shut-off valves
Two-stage function

MB-ZRD(LE) 415 - 420 B01



Volumetric flow pressure loss characteristics in regulated state with microfilter

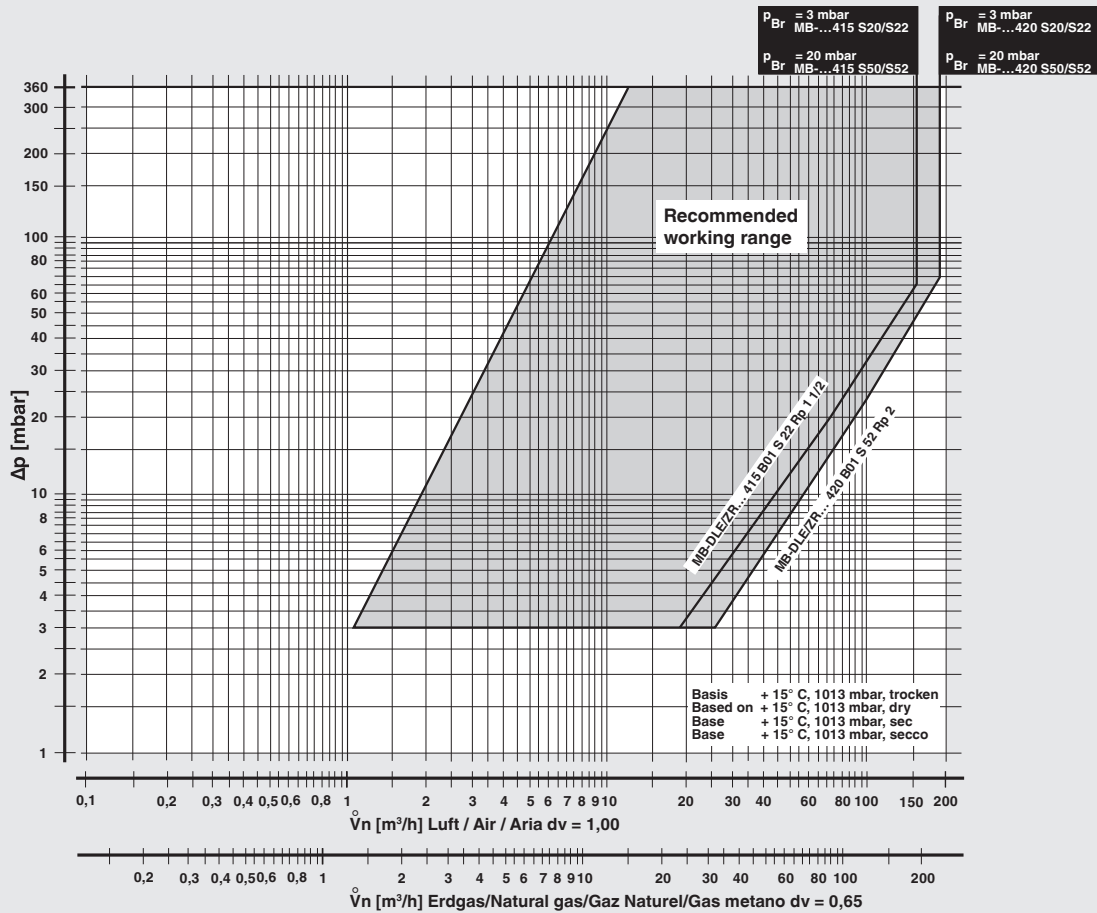

$$f = \sqrt{\frac{\text{Dichte Luft}}{\text{Dichte des verwendeten Gases}}}$$

Spec. weight air / poids spécifique de l'air / peso specifico aria

Spec. weight of gas used / poids spécifique du gaz utilisé / peso specifico del gas utilizzato

Gas type	Density [kg/m³]	dv	f
Nat. gas	0.81	0.65	1.24
City gas	0.58	0.47	1.46
LPG	2.08	1.67	0.77
Air	1.24	1.00	1.00

$$\dot{V}_{\text{verwendetes Gas/gas used/ gaz utilisé/gas utilizzato}} = \dot{V}_{\text{Luft/air/aria}} \times f$$

We reserve the right to make any changes in the interest of technical progress.

Head Offices and Factory
Karl Dungs GmbH & Co. KG
Siemensstraße 6-10
D-73660 Urbach, Germany
Telephone +49 (0)7181-804-0
Fax +49 (0)7181-804-166

Postal address
Karl Dungs GmbH & Co. KG
Postfach 12 29
D-73602 Schorndorf, Germany
e-mail info@dungs.com
Internet www.dungs.com