

RS 300÷1200/M BLU SERIES

The RS 300-400-500-650-800-1000-1200/M BLU burners are characterised by a monoblock structure which means that all necessary components are combined in a single unit, making installation easier and faster.

The burners cover a firing range from 1350 to 11100 kW, and they have been designed for use in hot water boilers or industrial steam generators.

Operation can be "two stage progressive" or alternatively "modulating" with the installation of a PID logic regulator or by external 4-20 mA/0-10 V signal.

The mechanical cam device of regulation allows to catch up a high modulation ratio on all firing rates range. The burners can, therefore, supply with precision the demanded power, guaranteeing a high efficiency system level and the stability setting, obtaining fuel consumption and operating costs reduction.

The combustion head, engineered with advanced simulation devices, guarantees reduced polluting emissions ($NO_x < 80 \text{ mg/kWh}$).

FS1 and FS2 versions are available for intermittent and continuous operation applications.

An exclusive design, guarantees low sound emissions, low electrical consumption, easy use and maintenance.



RS 300/M BLU	500/1350 ÷ 3800 kW
RS 400/M BLU	950/1830 ÷ 4590 kW
RS 500/M BLU	1000/2500 ÷ 5170 kW
RS 650/M BLU	1410/3000 ÷ 6500 kW
RS 800/M BLU	1200/3500 ÷ 8100 kW
RS 1000/M BLU	1100/4000 ÷ 10100 kW
RS 1200/M BLU	1500/5500 ÷ 11100 kW

Low NOx Modulating Gas Burners

RS 300÷1200/M BLU SERIES

FIRING RATES

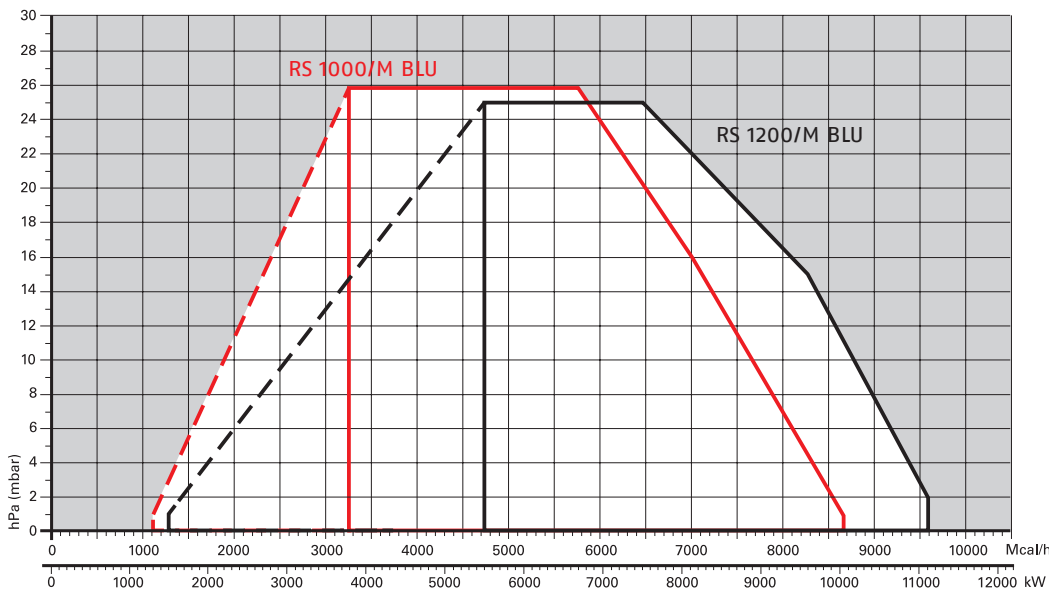
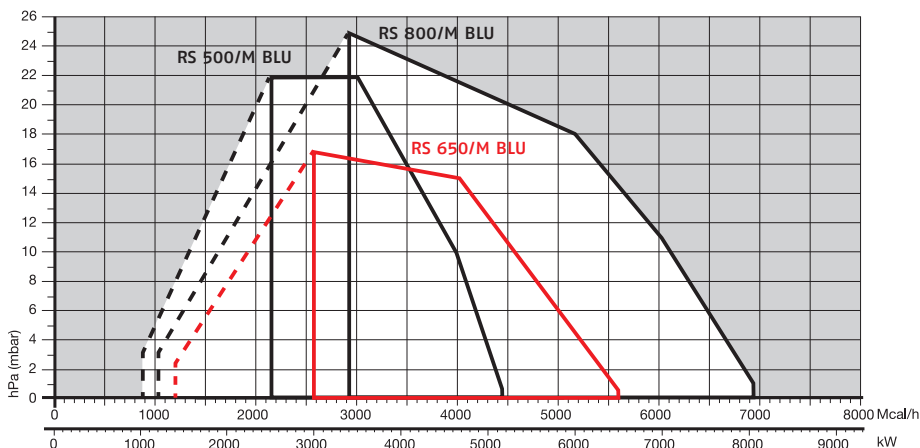
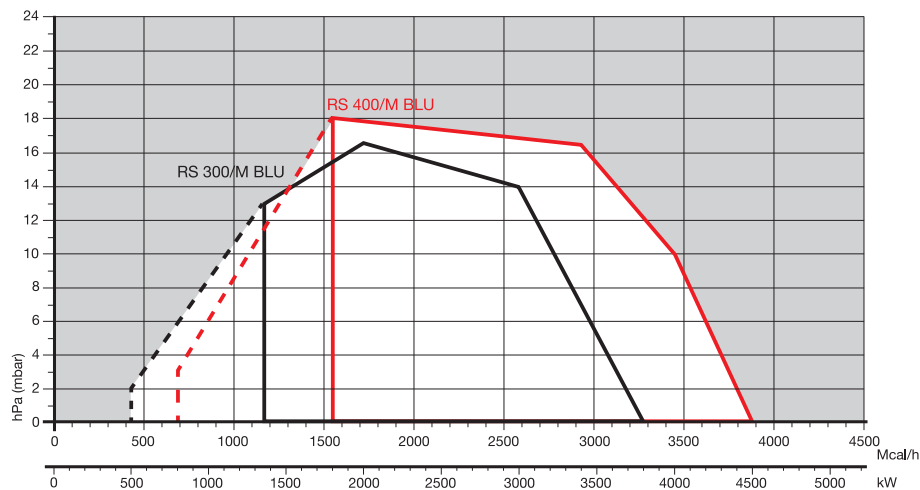

Overall dimensions (mm)

BURNER

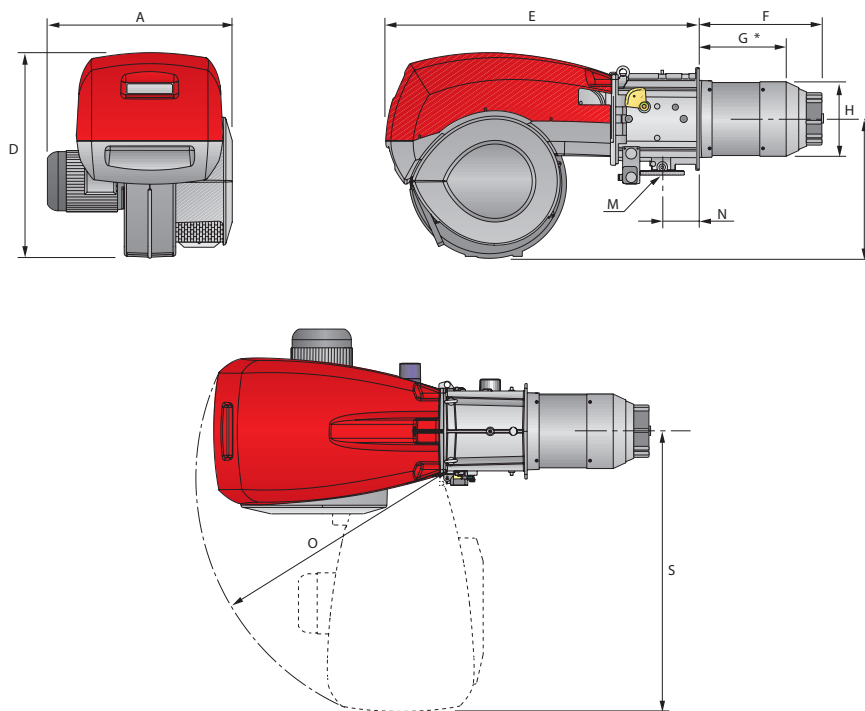

MODEL	A	D	E	F	G*	H	I	M	N	O	S
▶ RS 300/M BLU	720	867	1325	521	373	313	588	DN65	164	1055	1175
▶ RS 400/M BLU	775	867	1325	521	373	313	588	DN65	164	1055	1175
▶ RS 500/M BLU	775	867	1325	521	357	370	588	DN65	164	1055	1175
▶ RS 650/M BLU	800	950	1325	549	397	363	588	DN65/80	175	1055	1175
▶ RS 800/M BLU	940	867	1325	582	418	363	588	DN65/80	164	1055	1175

* Maximum depth of the boiler door including the depth of the burner flange insulating gasket.

BURNER - BOILER MOUNTING FLANGE

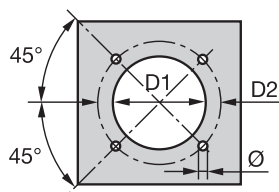

MODEL	D1	D2	Ø
▶ RS 300/M BLU	350	452	M18
▶ RS 400/M BLU	350	452	M18
▶ RS 500/M BLU	390	452	M18
▶ RS 650/M BLU	400	495	M18
▶ RS 800/M BLU	400	495	M18

PACKAGING

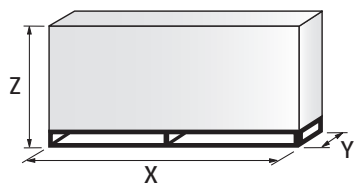

MODEL	X	Y	Z	kg
▶ RS 300/M BLU	1960	945	1100	225
▶ RS 400/M BLU	1960	945	1100	236
▶ RS 500/M BLU	1960	945	1100	250
▶ RS 650/M BLU	2040	1180	1125	300
▶ RS 800/M BLU	2040	1180	1125	300

Low NOx Modulating Gas Burners

RS 300-1200/M BLU SERIES

Overall dimensions (mm)

BURNER

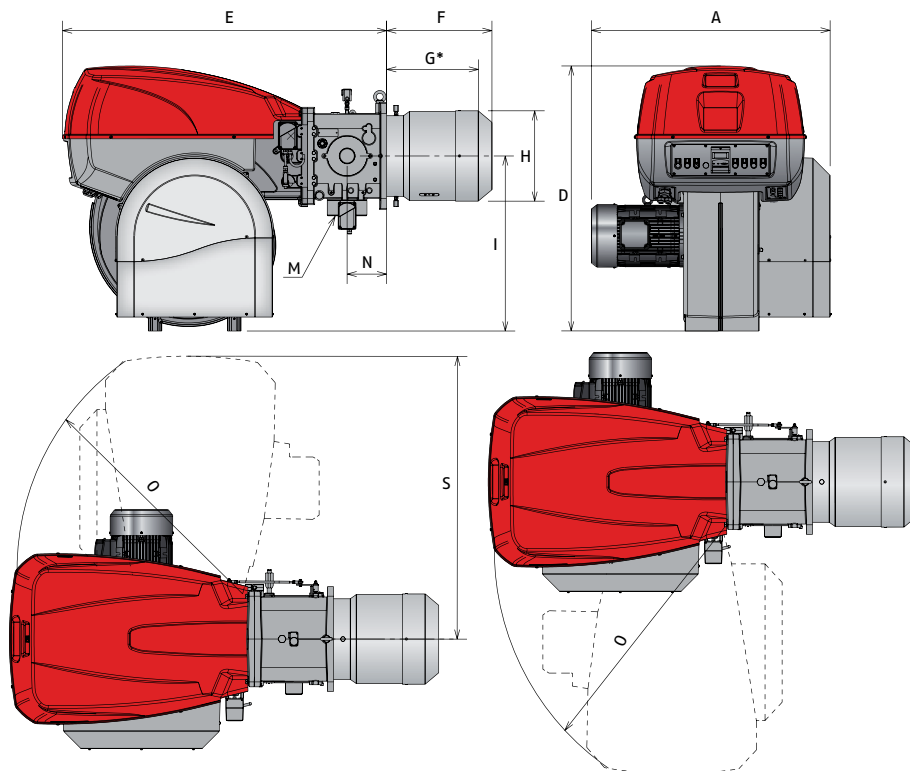

MODEL	A	D	E	F	G*	H	I	M	N	O	S
▶ RS 1000/M BLU	1206	1338	1637	669	485	413	885	DN80	200	1350	1493
▶ RS 1200/M BLU	1250	1338	1637	670	485	456	885	DN80	200	1350	1493

* Maximum depth of the boiler door including the depth of the burner flange insulating gasket.

BURNER - BOILER MOUNTING FLANGE

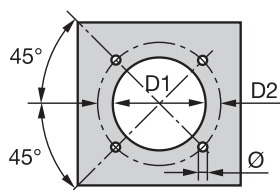

MODEL	D1	D2	Ø
▶ RS 1000/M BLU	460	608	M20
▶ RS 1200/M BLU	500	608	M20

PACKAGING

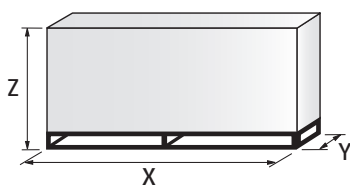

MODEL	X	Y	Z	kg
▶ RS 1000/M BLU	2400	1400	1595	500
▶ RS 1200/M BLU	2400	1400	1595	550

RS 300÷1200/M BLU SERIES

Specification

DESIGNATION OF SERIES

Series: R										
Fuel:		S	Natural Gas							
		L	Light oil							
		LS	Light oil/Natural Gas							
		N	Heavy oil							
Size										
Setting :		/1	Single stage							
		/B	Two stage							
		/M	Modulating - Mechanical cam							
		/P	Proportioning air/gas valve							
		/E	Electronic cam							
		/EV	Electronic cam predisposed for variable speed (with inverter)							
Emission :		...	Class 1 EN267 - EN676							
		MZ	Class 2 EN267 - EN676							
		BLU	Class 3 EN267 - EN676							
		MX	Class 2 EN267 Class 3 EN676							
Head length:		TC	standard head							
		TL	extended head							
Flame control system:		FS1	Standard (1 stop every 24 h)							
		FS2	Continuous working (1 stop every 72 h)							
Electrical supply to the system:		1/230/50	1/230V/50Hz							
		3/230/50	3/230V/50Hz							
		3/400/50	3N/400V/50Hz							
		3/230-400/50	3/230V/50Hz - 3N/400V/50Hz							
		3/220/60	3/220V/60Hz							
		3/380/60	3N/380V/60Hz							
		3/220-380/60	3/220/60Hz - 3N/380V/60Hz							
Auxiliary voltage:		230/50-60	230V/50-60Hz							
		110/50-60	110V/50-60Hz							

R	S	500	/M	BLU	TC	FS1	3/230-400/50	230/50-60
BASIC DESIGNATION								
EXTENDED DESIGNATION								



LOW NOx GAS

Low NOx Modulating Gas Burners

RS 300÷1200/M BLU SERIES

Specification

STATE OF SUPPLY

Monoblock forced draught gas burner with modulating operation, fully automatic, made up of:

- High performance fan with low sound emissions, reverse curve blades for RS 300-400-1000-1200/M BLU, forward curve blades for RS 500-650-800/M BLU
- Air suction circuit lined with sound-proofing material
- Air damper for air setting controlled by a high precision servomotor
- Air pressure switch
- Fan starting motor at 2900 rpm, three-phase 230/400 - 400/690 V with neutral, 50 Hz
- Low emission combustion head, that can be set on the basis of required output, fitted with:
 - stainless steel end cone, resistant to corrosion and high temperatures
 - ignition electrodes; or UV sensor (RS 1000-1200) for flame detection
 - flame stability disk
- Maximum gas pressure switch, with pressure test point, for halting the burner in the case of over pressure on the fuel supply line
- Burner safety control box for controlling the system safety (RMG/M for FS1 intermittent operation - LFL for FS1 intermittent operation for RS 1000-1200 model - LGK16 for FS2 continuous operation)
- UV photocell or ionisation probe for flame detection
- Star/delta starter for the fan motor (burners with motor electrical power $\geq 7,5$ kW)
- Main electrical supply terminal board
- Burner on/off switch
- Auxiliary voltage led signal
- Manual or automatic output increase/decrease switch
- Burner working led signal
- Contacts motor and thermal relay with release button
- Motor internal thermal protection
- Motor failure led signal
- Burner failure led signal and lighted release button
- Led signal for correct rotation direction of fan motor
- Emergency button
- Coded connection plugs-sockets
- Burner opening hinge
- Lifting rings
- IP 54 electric protection level

Standard equipment:

- 1 flange gasket
- 8 screws for fixing the flange
- 1 thermal screen
- 4 screws for fixing the burner flange to the boiler
- Instruction handbook for installation, use and maintenance
- Spare parts catalogue.

RS 300÷1200/M BLU SERIES

Available models

Burners

CODE	MODEL					HEAT OUTPUT		TOTAL ELECTRICAL POWER (kW)	CERTIFICATION	NOTE
						NATURAL GAS				
						(kW)	(Nm ³ /h)			
3899410	RS 300/M BLU	TC	FS1	3/230-400/50	230/50-60	500/1350-3800	50/135-380	5	CE 0085BR0480	(1)
20008428	RS 300/M BLU	TC	FS1	3/220-380/60	220/50-60	500/1350-3800	50/135-380	5	-	(1)
3899510	RS 400/M BLU	TC	FS1	3/400/50	230/50-60	950/1830-4590	95/183-459	8,8	CE 0085BR0481	(1)
20008404	RS 400/M BLU	TC	FS1	3/380/60	220/50-60	950/1830-4590	95/183-459	8,8	-	(1)
3899110	RS 500/M BLU	TC	FS1	3/400/50	230/50-60	1000/2500-5170	100/250-517	10,6	CE 0085B00341	(1)
3899115	RS 500/M BLU	TC	FS2	3/400/50	230/50-60	1000/2500-5170	100/250-517	10,6	CE 0085B00341	(1)
20006131	RS 500/M BLU	TC	FS1	3/380/60	220/50-60	1000/2500-5170	100/250-517	10,6	-	(1)
20040330	RS 650/M BLU	TC	FS1	3/400/50	230/50-60	1410/3000-6500	143/300-655	20,5	CE 0085BT0337	(1)
3911010	RS 800/M BLU	TC	FS1	3/400/50	230/50-60	1200/3500-8100	120/350-810	24	CE 0085BT0337	(1)
3911050	RS 800/M BLU	TC	FS2	3/400/50	230/50-60	1200/3500-8100	120/350-810	24	CE 0085BT0337	(1)
20008894	RS 800/M BLU	TC	FS1	3/380/60	220/50-60	1200/3500-8100	120/350-810	26	-	(1)
20051940	RS 1000/M BLU	TC	FS1	3/400/50	230/50-60	1100/4000-10100	130/380-940	24	CE-0085CN0119	(1) (2)
20072966	RS 1000/M BLU	TC	FS1	3/400/50	230/50-60	1100/4000-10100	130/380-940	24	CE-0085CN0119	(1) (3)
20051941	RS 1200/M BLU	TC	FS1	3/400/50	230/50-60	1500/5500-11100	150/550-1150	27,2	CE-0085CN0120	(1) (2)
20072965	RS 1200/M BLU	TC	FS1	3/400/50	230/50-60	1500/5500-11100	150/550-1150	27,2	CE-0085CN0120	(1) (3)

Natural gas, net calorific value: 10 kWh/Nm³ - Density: 0,71 kg/Nm³

(1) according to 2009/142 EC - 2004/108 - 2006/95 EC - 2006/42 EC Directives

(2) UV photocell

(3) ionization probe

Low NOx Modulating Gas Burners

RS 300÷1200/M BLU SERIES

Available models

Gas Trains

Code	Gas train			VPS Code	Adapter Code		
	Model	Ø	C.T.		RS 300	RS 400	RS 500
3970180*	MB 415/1 - RT 30	Rp 1" 1/2	-	3010123	20064220 + 20064169 / (20068062) ¹	●	●
3970198**	MB 415/1 CT RT 30	Rp 1" 1/2	◆	-		●	●
3970250*	MB 415/1 - RT 52	Rp 1" 1/2	-	3010123		●	●
3970253**	MB 415/1 CT RT 52	Rp 1" 1/2	◆	-		●	●
3970232*	MB 415/1 - RSM 30	Rp 1" 1/2	-	3010123		●	●
3970181*	MB 420/1 - RT 30	Rp 2"	-	3010123	20042324 + 20064169 / (20068062) ¹	●	●
3970182**	MB 420/1 CT RT 30	Rp 2"	◆	-		●	●
3970257*	MB 420/1 - RT 52	Rp 2"	-	3010123		●	●
3970252**	MB 420/1 CT RT 52	Rp 2"	◆	-		●	●
3970233*	MB 420/1 - RSM 30	Rp 2"	-	3010123		●	●
3970234**	MB 420/1 CT RSM 30	Rp 2"	◆	-	●	●	
3970221*	MBC 1200/1 - RSM 60	Rp 2"	-	3010367	20042324 + 20064169 / (20068062) ¹		
3970225**	MBC 1200/1 CT RSM 60	Rp 2"	◆	-			
3970222*	MBC 1900/1 - FSM 40	DN 65	-	3010367	20059330 / (20065924 + 20059330) ¹ / (3010221 + 20059331) ²		
3970226**	MBC 1900/1 CT FSM 40	DN 65	◆	-			
3970223*	MBC 3100/1 - FSM 40	DN 80	-	3010367	20059331 / (20065937 + 20059331) ¹ / (3010222 + 20059331) ²		
3970227**	MBC 3100/1 CT FSM 40	DN 80	◆	-			
3970224*	MBC 5000/1 - FSM 80	DN 100	-	3010367	20059332 / (20065960 + 20059332) ¹ / (3010223 + 20059331) ²		
3970228**	MBC 5000/1 CT FSM 80	DN 100	◆	-			
3970145*	CB 512/1 - RSM 30	Rp 1" 1/2	-	3010367	20064220 + 20064169 / (20068062) ¹	●	●
20045589**	CB 512/1 CT RSM 30	Rp 1" 1/2	◆	-		●	●
3970146*	CB 520/1 - RSM 30	Rp 2"	-	3010367	20042324 + 20064169 / (20068062) ¹		
3970160**	CB 520/1 CT RSM 30	Rp 2"	◆	-			
20044659*	CB 525/1 - RSM 30	Rp 2"	-	3010367	20042324 + 20064169 / (20068062) ¹		
20044660**	CB 525/1 CT RSM 30	Rp 2"	◆	-			
3970147*	CB 5065/1 - FSM 30	DN 65	-	3010367	20059330 / (20065924 + 20059330) ¹ / (3010221 + 20059331) ²		
3970161**	CB 5065/1 CT FSM 30	DN 65	◆	-			
3970148*	CB 5080/1 - FSM 30	DN 80	-	3010367	20059331 / (20065937 + 20059331) ¹ / (3010222 + 20059331) ²		
3970162**	CB 5080/1 CT FSM 30	DN 80	◆	-			
3970149*	CB 50100/1 - FSM 30	DN 100	-	3010367	20059332 / (20065960 + 20059332) ¹ / (3010223 + 20059331) ²		
3970163**	CB 50100/1 CT FSM 30	DN 100	◆	-			
20015871*	CB 50125/1 - FSM 30	DN 125	-	3010367	20059333 / (20065968 + 20059333) ¹ / (3010224 + 20059331) ²		
3970196**	CB 50125/1 CT FSM 30	DN 125	◆	-			

Please see designation of Gas Train Series in the page before the Catalogue index.

* 230V/50Hz -220V/60Hz electrical supply.

** 230V/50Hz electrical supply.

The valve seal control device is compulsory (conforming to EN 676) on gas trains to burners with a maximum output over 1200 kW.

To select the gas train please refer to the technical data leaflet and/or instruction manual.

C.T. Gas valve leak detection control device:

- gas train not equipped with leak detection control device; this device can be ordered separately - see VPS column - and installed later.

◆ gas train equipped with leak detection control device.

VPS Valve leak detection control device. Supplied separately from the gas train (please see Gas train accessories paragraph for both 50 Hz and 60 Hz codes).

● Not available.

1) To be used with gas train and burner opening on the left (fan motor side).

2) To be used with /M (mechanical cam) burners, gas train on the left (fan motor side) and burner opening on the right.

RS 300÷1200/M BLU SERIES

Available models

Gas Trains

Code	Gas train			VPS Code	Adapter Code			
	Model	∅	C.T.		RS 650	RS 800	RS 1000	RS 1200
3970221*	MBC 1200/1 - RSM 60	Rp 2"	-	3010367	20042324 + 20064169 / (20068062) ¹		20066253 / (20068058) ¹	
3970225**	MBC 1200/1 CT RSM 60	Rp 2"	◆	-				
3970222*	MBC 1900/1 - FSM 40	DN 65	-	3010367	20059330 / (20065924 + 20059330) ¹ / (3010221 + 20059331) ²		20066263 / (20065924 + 20066263) ¹	
3970226**	MBC 1900/1 CT FSM 40	DN 65	◆	-				
3970223*	MBC 3100/1 - FSM 40	DN 80	-	3010367	20059331 / (20065937 + 20059331) ¹ / (3010222 + 20059331) ²		20066268 / (20065937 + 20066268) ¹	
3970227**	MBC 3100/1 CT FSM 40	DN 80	◆	-				
3970224*	MBC 5000/1 - FSM 80	DN 100	-	3010367	20059332 / (20065960 + 20059332) ¹ / (3010223 + 20059331) ²		20066278 / (20065960 + 20066278) ¹	
3970228**	MBC 5000/1 CT FSM 80	DN 100	◆	-				
20044659*	CB 525/1 - RSM 30	Rp 2"	-	3010367	20042324 + 20064169 / (20068062) ¹	●	20066263 / (20065924 + 20066263) ¹	●
20044660**	CB 525/1 CT RSM 30	Rp 2"	◆	-		●		●
3970147*	CB 5065/1 - FSM 30	DN 65	-	3010367	20059330 / (20065924 + 20059330) ¹ / (3010221 + 20059331) ²		20066268 / (20065937 + 20066268) ¹	
3970161**	CB 5065/1 CT FSM 30	DN 65	◆	-				
3970148*	CB 5080/1 - FSM 30	DN 80	-	3010367	20059331 / (20065937 + 20059331) ¹ / (3010222 + 20059331) ²		20066278 / (20065960 + 20066278) ¹	
3970162**	CB 5080/1 CT FSM 30	DN 80	◆	-				
3970149*	CB 50100/1 - FSM 30	DN 100	-	3010367	20059332 / (20065960 + 20059332) ¹ / (3010223 + 20059331) ²		20066284 / (20065968 + 20066284) ¹	
3970163**	CB 50100/1 CT FSM 30	DN 100	◆	-				
20015871*	CB 50125/1 - FSM 30	DN 125	-	3010367	20059333 / (20065968 + 20059333) ¹ / (3010224 + 20059331) ²		20066284 / (20065968 + 20066284) ¹	
3970196**	CB 50125/1 CT FSM 30	DN 125	◆	-				

Please see designation of Gas Train Series in the page before the Catalogue index.

* 230V/50Hz - 220V/60Hz electrical supply.

** 230V/50Hz electrical supply.

The valve seal control device is compulsory (conforming to EN 676) on gas trains to burners with a maximum output over 1200 kW.

To select the gas train please refer to the technical data leaflet and/or instruction manual.

C.T. Gas valve leak detection control device:

- gas train not equipped with leak detection control device; this device can be ordered separately - see VPS column - and installed later.

◆ gas train equipped with leak detection control device.

VPS Valve leak detection control device. Supplied separately from the gas train (please see Gas train accessories paragraph for both 50 Hz and 60 Hz codes).

● Not available.

1) To be used with gas train and burner opening on the left (fan motor side).

2) To be used with /M (mechanical cam) burners, gas train on the left (fan motor side) and burner opening on the right.

Low NOx Modulating Gas Burners

RS 300÷1200/M BLU SERIES

Burner accessories

Extended head kit

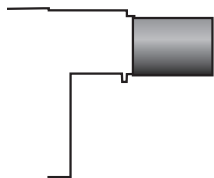

“Standard head” burners can be transformed into “extended head” versions, by using the special kit. The KITS available for the various burners, giving the original and the extended lengths, are listed below.

BURNER	STANDARD HEAD LENGTH (mm)	EXTENDED HEAD LENGTH (mm)	KIT CODE
▶ RS 300-400/M BLU	521 (1) - 373 (2)	621 (1) - 473 (2)	3091427
▶ RS 300-400/M BLU	521 (1) - 373 (2)	671 (1) - 523 (2)	3091919
▶ RS 300-400/M BLU	521 (1) - 373 (2)	721 (1) - 573 (2)	20022815
▶ RS 500/M BLU	521 (1) - 357 (2)	671 (1) - 507 (2)	20028449

(1) referred to quote F

(2) referred to quote G

Accessories for modulating operation

POWER CONTROLLER



To obtain modulating operation, the RS/M BLU series of burners requires a regulator with three point outlet controls. The following table lists the accessories for modulating operation with their application range.

BURNER	TYPE	CODE
▶ All models	RWF 40 - Basic version with 3 position output	3010356
	RWF 40 - High version with additional modulating output and RS 485 Interface	3010357

PROBE



The relative temperature or pressure probes fitted to the power controller must be chosen on the basis of the application.

BURNER	TYPE	RANGE (°C) (bar)	CODE
▶ All models	Temperature PT 100	-100 ÷ 500°C	3010110
	Pressure 4 ÷ 20 mA	0 ÷ 2,5 bar	3010213
	Pressure 4 ÷ 20 mA	0 ÷ 16 bar	3010214
	Pressure 4 ÷ 20 mA	0 ÷ 25 bar	3090873

ANALOG CONTROL SIGNAL CONVERTER



BURNER	TYPE (INPUT SIGNAL)	CODE
▶ All models	0/2 - 10 V (impedance 200 KΩ) 0/4 - 20 mA (impedance 250 Ω)	3010390

POTENTIOMETER



BURNER	KIT CODE
▶ RS 300-400-500-650-800/M BLU	3010402
▶ RS 1000-1200/M BLU	In progress

Burner accessories

Continuous ventilation kit



If the burner requires continuous ventilation in the stages without flame, a special kit is available as given in the following table:

BURNER	KIT CODE
▶ RS 300-400-500-800/M BLU	3010094
▶ RS 1000-1200/M BLU	20086519

UV cell kit



A UV cell is available for the supervision of the flame alternatively to ionisation probe for special applications.

BURNER	KIT CODE
▶ RS 300-400-500-650-800/M BLU	3010359

PC interface kit



To connect the control box to a personal computer for the transmission of operation, fault signals and detailed service information, an interface adapter with PC software are available.

BURNER	KIT CODE
▶ RS 300-400-500-800/M BLU	3002719

Sound proofing box

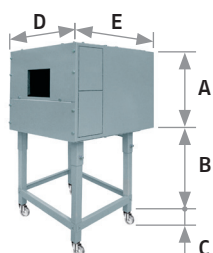

If noise emission needs reducing even further, sound-proofing boxes are available. In case of generator heights, where a lower dimension "B" is required, ask for the Box Support Kit code 20065135. The useful dimensions are 40 mm less than the total dimensions indicated in the table (A, D, E). Not suitable for outdoor use.

BURNER	BOX TYPE	A (mm)	B (mm) min-max	C (mm)	D (mm)	E (mm)	[dB(A)] (*)	BOX CODE
▶ RS 300-400-500/M BLU RS 650-800/M BLU	C7	1255	160 - 980	110	1140	1345	10	3010376
▶ RS 1000-1200/M BLU	C8	1425	285 - 1000	110	1500	1800	10	3010401

(*) Average noise reduction according to EN 15036-1 standard

LPG kit



For burning LPG gas, a special kit is available to be fitted to the combustion head of the burner.

BURNER	CODE
▶ RS 300/M BLU	3010445 (*)
▶ RS 400-500/M BLU	20012916 (*)
▶ RS 650/M BLU	in progress
▶ RS 800/M BLU	20007822 (*)

(*) CE approved.

Low NOx Modulating Gas Burners

RS 300÷1200/M BLU SERIES

Burner accessories

Post-ventilation kit

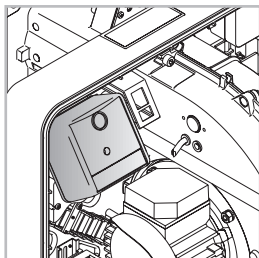

To have 20 s ventilation after opening of thermostats chain, a special kit is available.

BURNER	KIT CODE
► RS 300-400/M BLU	3010451

Spacer kit

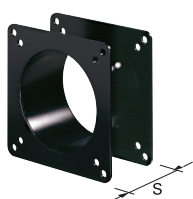





If burner head penetration into the combustion chamber needs reducing, varying thickness spacers are available, as given in the following table:

BURNER	SPACER THICKNESS S (mm)	KIT CODE
► RS 300-400-500-650-800/M BLU	180	20008903

Gas train accessories

Adapters

In certain cases, an adapter must be fitted between the gas train and the burner, when the diameter of the gas train is different from the set diameter of the burner. Below are given the available adapters; please see on the Gas Train list the correct adapter codes to select.

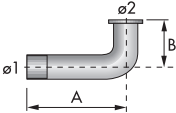
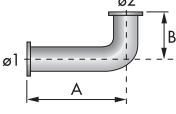
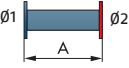
ADAPTER	DIMENSIONS				ADAPTER CODE
	Ø1 DN	Ø2 DN	A mm	B mm	
1" 1/2  2"	-	-	65	-	20064220
2"  2"	-	-	65	-	20042324
DN 80  2" 1/2  2"	-	-	300	-	3000826
	2"	65 / 80	230	230	20064169
	2"	65 / 80	780	230	20068062
	2"	65 / 80	780	230	20068058
	65	65 / 80	230	230	20059330
	80	65 / 80	230	230	20059331
	100	65 / 80	230	230	20059332
	125	65 / 80	245	230	20059333
	2"	65 / 80	230	375	20066253
	65	65 / 80	230	375	20066263
	80	65 / 80	230	375	20066268
	100	65 / 80	230	375	20066278
	125	65 / 80	245	375	20066284
	65	80	400	-	3010221
	80	80	400	-	3010222
	100	80	400	-	3010223
	125	80	320	-	3010224
	65	65	800	-	20065924
	80	80	800	-	20065937
	100	100	800	-	20065960
	125	125	800	-	20065968

RS 300÷1200/M BLU SERIES

Gas train accessories

Stabiliser spring



To vary the pressure range of the gas train stabilisers, accessory springs are available. The following table shows these accessories with their application range. Please refer to the technical manual for the correct choice of spring.

GAS TRAIN	SPRING COLOUR	SPRING PRESSURE RANGE mbar	SPRING CODE
▶ MBC 1900/1 - 3100/1 MBC 5000/1	White	4 - 20	3010381
	Red	20 - 40	3010382
	Black	40 - 80	3010383
	Green	80 - 150	3010384
▶ CB 512/1	Red	25 - 55	3010131
	Black	60 - 110	3010157
	Pink	90 - 150	3090486
▶ CB 520/1 - 525/1	Red	25 - 55	3010132
	Black	60 - 110	3010158
	Pink	100 - 150	3090487
▶ CB 5065/1 - 5080/1	Red	25 - 55	3010133
	Black	60 - 110	3010135
	Pink	100 - 150	3090456
	Grey	140 - 200	3090992
▶ CB 50100/1	Red	25 - 55	3010134
	Black	60 - 110	3010136
	Pink	100 - 150	3090489
	Grey	140 - 200	3092174
▶ CB 50125/1	Red	25 - 55	3010315
	Yellow	30 - 70	3010316
	Black	60 - 110	3010317
	Pink	100 - 150	3010318

Seal control kit



To test the valve seals on the gas train, a special "seal control kit" is available. The valve seal control device is compulsory (EN 676) on gas trains to burners with a maximum output over 1200 kW. The seal control is type VPS 504.

GAS TRAIN	KIT CODE for 50 Hz operation	KIT CODE for 60 Hz operation
▶ MB/1 type	3010123	20050030
▶ MCB/1 type	3010367	20050030